

4-H EQUINE PROGRAM RULE BOOK

WASHINGTON STATE UNIVERSITY

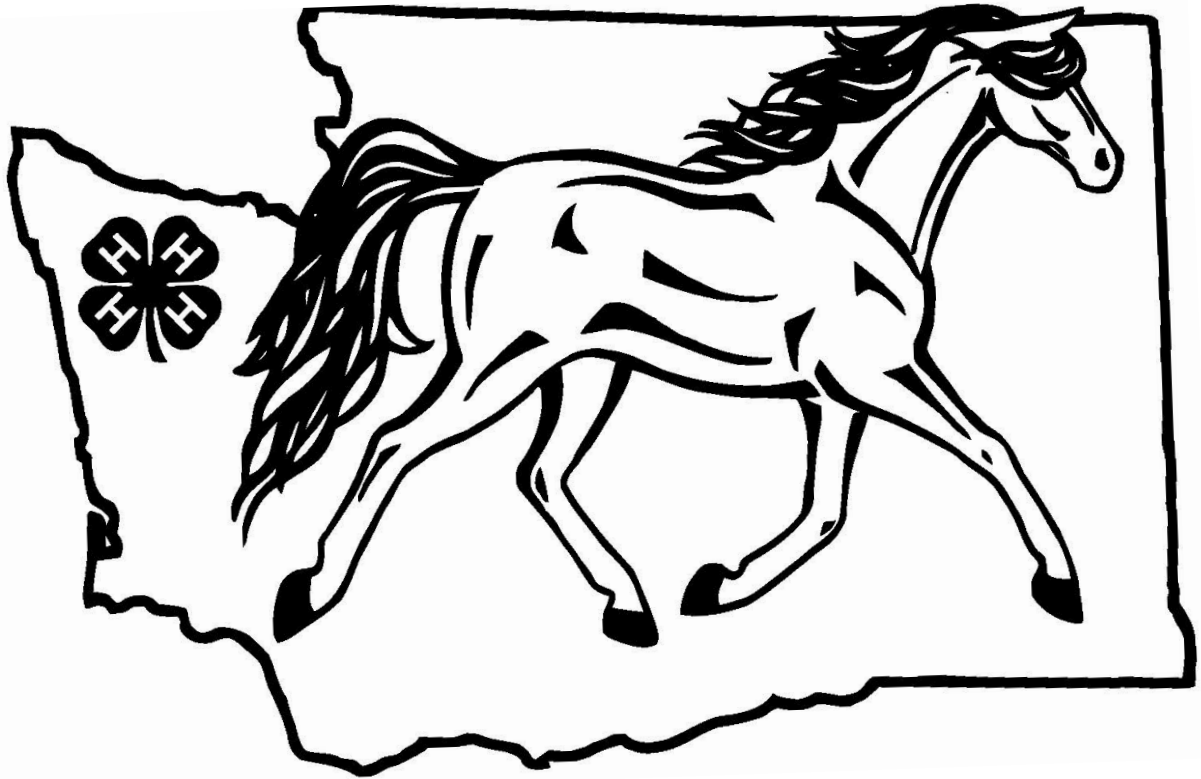

Published date: March 2024

WSU is an affirmative-action, equal-opportunity employer. Washington State University Extension programs and materials are open to all without regard to race, color, national origin, sex, gender, gender identity, religion, age, height, weight, disability, political beliefs, sexual orientation, marital status, family status or veteran status. Evidence of noncompliance may be reported through your local extension office or the WSU Compliance and Civil Rights Office at ccr@wsu.edu or 509-335-8288.

4-H EQUINE PROGRAM RULEBOOK

INTRODUCTION

Welcome to your new Washington State 4-H Equine Program Rule Book! This Rule Book supersedes the previous PNW Contest Guide for Washington State. While there are very few actual rule changes there are many additions. To highlight these, all changes and additions are in "Blue Colored Font". The procedure for recommending changes and additions is on the back page of this document.

The 4-H Equine Project is aimed at the personal growth of youth. Exhibiting is one avenue of this development. Emphasis should be on good sportsmanship and trying one's best rather than on winning.

These rules for governing 4-H Equine competitions are designed to maintain uniformity of 4-H shows in County and State events and to provide a learning resource for the members and volunteers. Requirements are designed to be basic enough to encourage new members to exhibit yet open enough to keep the interest of experienced exhibitors. In the Dress Code and Equipment, there are certain appointments that are optional that may be required in non-4-H Shows. Youth should be aware of this; however, no members should feel the need for these optional items for 4-H Shows, Fairs or State 4-H Fair.

These contest rules are 4-H policy for Washington State 4-H Horse program. Refer to the Horse Page on the [WSU 4-H Animal Science website](#) for updates and additional information.

4-H events and activities are under the direction and oversight of Washington State University, the state land grant university, and WSU Extension. WSU policies and procedures take priority over all 4-H rules, policies, and procedures. If there are discrepancies between WSU and 4-H, WSU policies and procedures supersede these differences. Refer to the [Washington State 4-H Program policy publication](#) (EM0758) located on [the Member Resource page of the WSU 4-H state website](#) and/or contact your respective county 4-H professional.

This State Rule Book contains general rules and guidelines for competitive activities in the 4-H Horse program. Contests help youth measure progress in knowledge and skill in horsemanship. They also provide opportunities to learn social skills and have fun.

Counties are bound by state rules and may not make their rules less restrictive; however, counties may make more restrictive rules but cannot be contrary to overall Washington 4-H Program Policies as listed in EM0758E (publication number) and found on WSU 4-H website.

Open shows using the 4-H name and emblem are bound by Washington State 4-H Equine Rules and also the Washington State 4-H Program Policies. Failure to do so puts the respective county 4-H program at risk along with the any other sponsoring 4-H organization and will not be covered by WSU liability nor American Income life insurance.

[Return to Table of Contents](#)

4-H EQUINE PROGRAM RULEBOOK

Counties should create rules and criteria for “county only” classes not addressed in this guide. This makes it easier for leaders to teach and judges to evaluate a member’s performance.

These rules may result in dismissal from the show and/or forfeiture of all awards. In addition, any gross abuse of these rules could result in the removal of a 4-H member from the 4-H program [as per the 4-H member Code of Conduct and at the direction of the State 4-H Program Leader](#).

In addition to this guide and information provided by local show committees, there are several support publications available. 4-H members, leaders, and parents are strongly encouraged to read the following 4-H horse manuals before using this rule book to better understand the terminology and context for the information provided here. Additional resources are listed below for those interested in related activities and opportunities. If any discrepancies exist between sources, this document takes precedence over all other material.

PNW Resources (all of which are located on the [WSU 4-H Animal Science website](#).)

- 4-H Driving Manual (PNW 229)
- 4-H Hunt Seat and Jumper Manual (PNW 488)
- 4-H Horse Judging Manual (PNW 575)
- The 4-H Horse Project (PNW 587)
- 4-H Dressage Manual (PNW 608)

Washington Resources

- [Washington State University 4-H Horse Page](#)
- [Beginning Horsemanship \(EM4842E\)](#)

National Resources

- [Horses & Horsemanship Curriculum Page](#)
- [Horse Science Curriculum Page](#)

Additional horse project resources and projects/rules specific to the Washington 4-H horse program are located on the [WSU 4-H Animal Science website](#).

Members who wish to participate in open or breed shows should check appropriate show rules for tack, dress, and performance requirements.

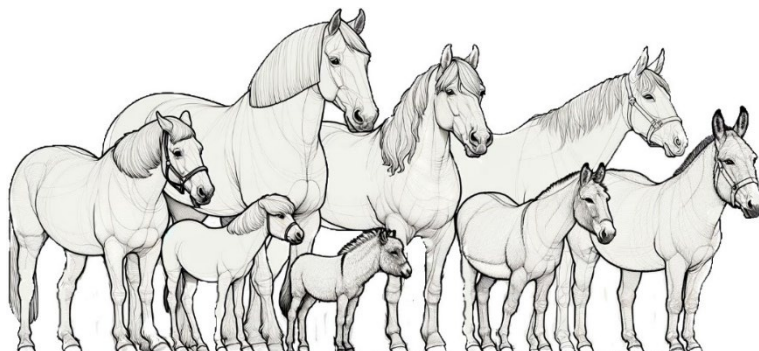

[Return to Table of Contents](#)

4-H EQUINE PROGRAM RULEBOOK

TABLE OF CONTENTS

MISSION	12
GR – General Rules.....	13
GR101 – Participation Guidelines	13
GR102 - Coaching	13
GR103 – Use, Condition, and Treatment of Equine	13
GR104 – Accommodations	13
GR105 – Age of Equine.....	14
GR106 – Equine Project(s).....	14
Equine Project(s) Qualification	14
1. Possession.....	14
Project Equine.....	14
1. Shared Projects.....	14
2. Replacement.....	15
3. Gaited Equines.....	15
GR107 - Show Protocol	15
Responsibilities of the Exhibitor	15
Responsibilities of Show Management	16
Responsibilities of the Judge	17
Ribbons and Awards	17
GR108 - Competition Divisions.....	18
GR109 - Medication and Equine Special Needs	18
GR110 - Volunteer Policy on Animal Disease Diagnosis and Treatment	18
GR111 - The 4-H Equestrian Headgear Policy	19
GR112 - Concussion Protocol	19
GR113 - Medals Program	19
CONTEST GUIDELINES	20
SH – Showmanship.....	20
SH101 - Purpose	20
SH102 – Scoring.....	20

4-H EQUINE PROGRAM RULEBOOK

SH103 – Attire	20
SH104 - Equipment.....	20
SH105 - Grooming Requirements	21
SH106 - Class Procedure.....	21
SH107 – Tests	22
HEQ - Hunt Seat Equitation.....	23
HEQ101 – Purpose	23
HEQ102 - Scoring.....	23
HEQ103 – Attire.....	23
HEQ104 - Equipment.....	23
HEQ105 – Grooming.....	24
HEQ106 – Class Procedure	24
HEQ107 – Tests	25
HOF - Hunt Seat Equitation Over Fences	26
HOF101 – Purpose.....	26
HOF102 – Scoring	26
HOF103 – Attire.....	26
HOF104 - Equipment	27
HOF105 - Grooming.....	27
HOF106 Class Procedure	27
SEQ - Saddle Seat Equitation	30
SEQ101 – Purpose	30
SEQ102 - Scoring	30
SEQ103 - Attire	30
SEQ104 – Equipment.....	31
SEQ105 – Grooming	31
SEQ106 – Class Procedure.....	31
SEQ107 – Tests	31
WEQ - Western Equitation.....	33
WEQ101 – Purpose	33
WEQ102 - Scoring.....	33

4-H EQUINE PROGRAM RULEBOOK

WEQ103 - Attire	33
WEQ104 - Equipment.....	33
WEQ105 – Grooming.....	36
WEQ106 – Class Procedure	36
WEQ107 – Tests	36
BEQ - Bareback Equitation	37
BEQ101 - Purpose.....	37
BEQ102 - Scoring.....	37
BEQ103 - Attire.....	37
BEQ104 – Tack.....	37
BEQ105 – Grooming.....	37
BEQ106 – Class Procedure	37
BEQ107 – Tests.....	38
TRR – Trail (Under Saddle) Ridden.....	39
TRR101 – Purpose	39
TRR102 - Scoring	39
TRR103 - Attire	39
TRR104 - Equipment.....	39
TRR105 – Grooming	39
TRR106 – Class Procedure.....	39
TRI – Trail In Hand.....	41
TRI101 – Purpose	41
TRI102 - Scoring.....	41
TRI103 - Attire	41
TRI104 - Equipment.....	41
TRI105 – Grooming.....	42
TRI106 – Class Procedure	42
Table 1 - Mandatory dimensions of trail obstacles.....	43
WG – Western Games.....	44
WG101 - Purpose	44
WG102 - Scoring.....	44

4-H EQUINE PROGRAM RULEBOOK

WG103 - Attire	45
WG104 - Equipment.....	45
WG105 – Grooming.....	49
WG106 Class Procedure.....	49
Table 2. Judges’ Hand Signals.....	50
Description of Approved Events.....	51
Figure 8 Stake Race.....	51
Idaho Figure 8.....	51
Pole Bending.....	52
Key Race.....	52
Barrels.....	53
Keyhole Race.....	53
Two-Barrel Flag Race	54
International Flag Race.....	55
DR – Dressage (English).....	56
DR101 – Purpose.....	56
DR102 – Scoring	56
DR103 - Attire.....	56
DR104 - Equipment	57
DR105 – Grooming	57
DR106 – Class Procedure	58
DR107 – Tests.....	58
DRE – Dressage (English) Seat Equitation.....	59
DRE101 - Purpose.....	59
DRE102 - Scoring.....	59
DRE103 - Attire.....	59
DRE104 - Equipment	59
DRE105 – Grooming.....	59
DRE106 – Class Procedure.....	60
WD - Western Dressage.....	61
WD101 – Purpose.....	61

4-H EQUINE PROGRAM RULEBOOK

WD102 – Scoring	61
WD103 - Attire	61
WD104 - Equipment	61
WD105 – Grooming.....	63
WD106 – Class Procedure	63
WD107 – Tests.....	63
WDE – Western Dressage Equitation	64
WDE101 – Purpose.....	64
WDE102 – Scoring	64
WDE103 - Attire	64
WDE104 - Equipment	64
WDE105 – Grooming.....	64
WDE106 – Class Procedure	64
DV – Driving.....	65
DV101 – Purpose	65
DV102 – Scoring	65
DV103 - Attire.....	65
DV104 - Equipment	66
DR105 –Grooming.....	67
DR106 – Class Procedures and Safety	67
DVR - Driving Reinsmanship.....	68
DVR101 - Purpose	68
DVR102 - Scoring.....	68
DVR103 - Attire.....	68
DVR104 - Equipment	68
DVR105 - Grooming.....	68
DVR106 - Class procedure	68
DVR107 – Tests.....	69
DVPr - Precision Driving	70
DVPr101 - Purpose	70
DVPr102 – Scoring.....	70

4-H EQUINE PROGRAM RULEBOOK

DVPr103 - Attire	70
DVPr104 - Equipment.....	70
DVPr105 - Grooming	70
DVPr106 - Class procedure.....	70
Sample Precision Driving Courses (Suggestions Only)	72
DVPL - Pleasure Driving.....	73
DVPL101 - Purpose.....	73
DVPL102 - Scoring	73
DVPL103 - Attire	73
DVPL104 - Equipment	73
DVPL105 - Grooming.....	73
DVPL106 - Class procedure	73
DD - Driven Dressage	74
DD101 - Purpose	74
DD102 - Scoring.....	74
DD103 - Attire.....	74
DD104 - Equipment.....	74
DD105 - Grooming.....	74
DD106 - Class Procedure	74
DD107 - Tests	74
SM – Small Equine In-Hand.....	75
SM101 - Purpose	75
SM102 - Scoring.....	75
SM103 - Attire	75
SM104 - Equipment.....	76
SM105 - Grooming	76
SMD – Small Equine Dressage In-Hand.....	77
SMD101 - Purpose.....	77
SMD102 - Scoring	77
SMD103 - Attire.....	77
SMD104 - Equipment	77

4-H EQUINE PROGRAM RULEBOOK

SMD105 - Grooming.....	77
SMD106 Class Procedure	77
SMD107 - Tests.....	78
Small Equine In-Hand - Sample Dressage Test Pattern.....	78
Small Equine In-Hand Scoresheet – Sample Dressage In-Hand (Side 1).....	79
Small Equine In-Hand Scoresheet – Sample Dressage In-Hand (Side 2).....	80
SMO – Small Equine Obstacles In-Hand	81
SMO101 – Purpose.....	81
SMO102 - Scoring.....	81
SMO103 - Attire.....	82
SMO104 - Equipment	82
SMO105 - Grooming.....	82
SMO106 - Class Procedures	82
Small Equine In-Hand – Obstacle In-Hand Scoresheet Sample (Side 1)	87
Small Equine In-Hand – Obstacle In-Hand Scoresheet Sample (Side 2)	88
SMH – Small Equine Hunter In-Hand	89
SMH101 – Purpose.....	89
SMH102 - Scoring	89
SMH103 - Attire.....	90
SMH104 - Equipment	90
SMH105 - Grooming.....	90
SMH106 - Class Procedures.....	90
Small Equine In-Hand – Hunter In-Hand Scoresheet Sample	93
RN – Reining.....	94
RN101 - Purpose.....	94
RN102 - Scoring.....	94
RN103 - Attire.....	96
RN104 - Equipment	96
DI – Disciplined Rail.....	97
DI101 - Purpose	97
DI102 – Scoring.....	97

4-H EQUINE PROGRAM RULEBOOK

DI103 - Attire	97
DI104 – Equipment.....	97
DI105 – Grooming	98
DI106 – Class Procedure.....	98
EP – Equine Presentations	99
GS – Groom Squad	99
HI - Hippology.....	99
HB – Horse Bowl.....	100
HJ – Horse Judging	100
HA – Horse Advancement Program	101
HH - Horseless Horse Project	101

4-H EQUINE PROGRAM RULEBOOK

MISSION

As part of the 4-H Youth Development Program, our mission is to use the 4-H Equine project as a vehicle for members to practice life skills while learning about the equine industry and how to safely handle, ride, and manage their horse.

4-H Motto:

To Make the Best Better

4-H Pledge:

I pledge my HEAD to clearer thinking,
My HEART to greater loyalty,
My HANDS to larger service,
And my HEALTH to better living
For my club, my community, my country, and my world.



4-H EQUINE PROGRAM RULEBOOK

GR – General Rules

GR101 – Participation Guidelines

1. 4-H members participating in any 4-H equestrian activity must be enrolled in the current 4-H year.
2. 4-H members participating in any 4-H equestrian activity must wear an approved helmet whenever they are mounted on an equine or are in a vehicle (cart, wagon, buggy, etc.) being pulled by an equine. An approved helmet meets the minimum performance standards imposed by the American Society for Testing Materials (ASTM) F1163 and includes certification and labeling required by the Safety Equipment Institute (SEI). The helmet must be properly fitted with the harness engaged and properly fastened according to manufacturer's instructions. It is recommended that 4-H'ers wear their ASTM/SEI helmets any time they are around their horse.
3. Only 4-H members may ride, groom, school, or handle a horse while on the show grounds. Junior members may have assistance with saddling and bridling if needed. Anyone may have assistance for safety reasons.

GR102 - Coaching

1. No one is allowed to coach contestants while the contestants are in the show ring.

GR103 – Use, Condition, and Treatment of Equine

1. Humane treatment of all animals is required. Exhibitors are expected to treat their animals with respect and provide for their continuous well-being through proper feeding, handling, disease prevention, sanitation, and attention to safety.
2. Horses should be well-groomed, clean, and clipped according to breed. Horses may be left natural, for example unclipped bridle path, tactile hair around eyes and muzzle, fetlock, as a personal choice with no penalty. Exhibitors may not decorate their horse with glitter, paint, or other means except in Western gaming or other specified county-only class. False tails are allowed but if not securely fastened, will result in disqualification.
3. The equine's feet should be clean and trimmed. Shoes are optional. Hoof boots may be allowed with a recommendation letter from a farrier or veterinarian. However, hoof boots are not allowed in Equitation Over Fences and Western Games.
4. A visibly ill, severely underweight, or unsound animal may be dismissed from participation by show personnel or at the judge's discretion.
5. Riders may use a bonnet or earplugs on their horses for safety reasons.
6. A horse not under control may be dismissed from the ring.
7. No one may ride a horse double at any time.
8. No one may ride a horse with a halter only.

GR104 – Accommodations

1. County committees may make accommodations for special circumstances at county 4-H events. An accommodation request related to a disability must be made through your local Extension/4-H staff at least two weeks prior to the event if possible. The decision of state participation is made at the county level in consultation with county 4-H staff.

4-H EQUINE PROGRAM RULEBOOK

2. Anyone attending a WSU Extension program that requires auxiliary aids or services should contact the organizer listed at least two weeks prior to the event. Requests made after two weeks prior to the event are not guaranteed implementation.

GR105 – Age of Equine

1. As stated in Washington State policy, no stallions over the age of 12 months may be exhibited.
2. Refer to specific divisions regarding equines age requirements.

GR106 – Equine Project(s)

Equine Project(s) Qualification

1. Possession

The goal of 4-H is to ensure that youth have opportunities within the four Essential Elements of the 4-H Youth Development Program (belonging, mastery, independence, and generosity). Projects are used as tools to promote positive youth development. The purpose of 4-H events is for 4-H members to demonstrate what they have accomplished with their projects during the year. The goals of the 4-H program are only met if the accomplishments demonstrated are the result of the 4-H member's own work. Therefore, project animals (owned, leased, or shared) must be under the care and management of the 4-H member at least 90 days before the animal may be shown at the official county exhibit activity. A lease agreement is permitted if the member provides primary care for the horse. Counties may require that a copy of the lease be included in the member's record book.

Project Equine

For the purpose of this Rule Book, Equine or Horse refers to Horses, Ponies, Donkeys, Mules, and Hinnies.

Each member is expected to have access to one or more horses that they may own, share, or lease.

The equine shown in a 4-H exhibit activity must be the member's project animal. To participate at state fair, an exhibitor must use the same equine that was exhibited at the county qualifying event.

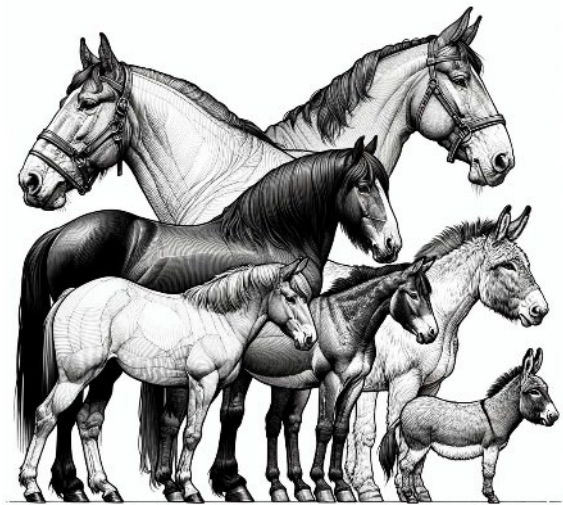

Stallions older than 12 months are NOT allowed in 4-H contests or events.

1. Shared Projects

A shared project equine is defined as one shared only by immediate family members or two non-family members, including both in care and training responsibilities. Members and parents must recognize that they may need to make adjustments, choices, or both to adapt to show conditions or schedules, such as when two members sharing a horse are in the same class or are competing for championships.

4-H EQUINE PROGRAM RULEBOOK

2. *Replacement*

Counties have the option to use an appeal board or variance committee process to determine if an animal can be replaced in the case of death, severe injury, or unsafe behavior. A successful appeal may show at the county level but will not be allowed to exhibit at state fair.

3. *Gaited Equines*

Gaited horses that pace, slow gait, fox trot, singlefoot, rack, or perform a running walk may be worked with the class, adjusting their speed to conform to the other horses. When riders are asked to post the trot on the rail or in a pattern, the intermediate gait is acceptable if that is the breed standard. However, if all other aspects of the performance are equal, a rider posting correctly will be given preference.

GR107 - Show Protocol

Responsibilities of the Exhibitor

The judge's decision is final; however, every exhibitor should have an opportunity to approach the judge to ask questions. This should be for educational purposes, not to dispute placings. The exhibitor should not approach the judge until after the final class of the day or as otherwise specified by the show committee. A parent or leader may be present. The contestant should provide their exhibitor number and any score sheets they may have received, but photos or any visual recordings are not allowed. The contestant should expect discussion or explanation on how to improve.



- A Members should be courteous and alert and follow instructions given by the judge or ring steward, including entering promptly when a class is called.
- B Contestant numbers must be clearly visible either on the rider's back or on both sides of the saddle pad. (The exhibitor is responsible for supplying the second number.)
- C [The member, equine, and equipment may be inspected at any time during the contest. Members using unsafe and/or illegal equipment may be asked to leave the ring at the judge's discretion.](#)
- D If an exhibitor needs a "gate hold" (delay of class) for equipment change, they must request this before the class is called to enter the arena. Delays may be penalized at the judge's discretion.
- E A red ribbon on the tail marks a horse that may kick if crowded.
- F Contestants are judged at all times when in the ring.
- G The 4-H member can pat/pet/stroke their horse after completion of their performance class/course/pattern (including Western Games) runs after the judging has been completed. Exception would be for in Showmanship as per [Showmanship Class Procedure](#).
- H Each member must have proper clothing and equipment for the specific classes entered (refer to the appropriate divisions below). Variations in clothing, tack, or both (including bandages on the horse) are permitted if there is a valid medical reason. However, a letter explaining the need for the variation, signed by the physician or veterinarian, must be presented to the show managers before the start of the show.

[Return to Table of Contents](#)

4-H EQUINE PROGRAM RULEBOOK

- I Boots are required for exhibitors in all classes except driving and small equine.
 - 1. Boots are defined as high-topped (above the ankle) leather or leather-like riding shoes with heels. (The boot must have an adequate heel to prevent it from moving forward through the stirrup.) Exhibitors must be able to move the boot freely in the stirrup and easily slide the boot out of the stirrup.
 - 2. Exhibitors in Driving and Small Equine must wear boots or hard-soled sturdy shoes. This also applies to Headers in Driving classes.
- J Equipment must be safe, clean, properly adjusted, and suitable for the class being shown. Exhibitors with equipment that does not meet these standards may lose points or possibly be eliminated. Equipment age or cost is not considered.
- K An exhibitor's hair must be worn in a net, braid(s), or other means to present a neat appearance and give the judge a clear view of the show number.
- L Members should be aware when a judge requests a movement to the right (off-side) or left (near-side), this is to the horse's right or left.

Responsibilities of Show Management

- A The judge's decision is final; however, it is Show Management's responsibility to provide an opportunity for exhibitors to approach judges. This information will be relayed to exhibitors during the informational meeting or by other means. Before the beginning of a class or show, questions about specific classes or rules must be addressed to ALL exhibitors, not one-to-one. Show committees need to remember that judges' decisions are final.
- B Show management (or the judge) reserves the right to dismiss any youth or party from any 4-H class or show for any misconduct, lack of sportsmanship, or rule infraction. Exhibitors thus dismissed may forfeit all awards received in the class or at the show. [The member, horse, and equipment may be inspected at any time during the contest. Members using unsafe and/or illegal equipment may be asked to leave the ring at the judge's discretion.](#)
- C Show Classes - Any or all of the classes listed in this guide may be offered at a show or fair where 4-H classes are conducted. At pre-fairs, county fairs, or any state qualifying event, Showmanship is required.
- D Class Priorities - When management must choose between equitation and pleasure classes, equitation classes must take priority. For example, Western Equitation and Bareback Equitation must be offered before Western Pleasure. If entries warrant, Saddle Seat or Hunter Seat Equitation must be offered before English Pleasure classes. If entries warrant, it is recommended that all shows offer at least two equitation classes and a showmanship class; for example, Western Equitation, Bareback Equitation, and Showmanship.



4-H EQUINE PROGRAM RULEBOOK

- E To be classified as a pony, the animal must be 56 or less inches high. When there are few ponies, counties have the option to combine horse and pony classes. When there are a great number of ponies, they may be divided into small pony and large pony divisions:
- 1.Small pony: any pony less than 48 inches high
 - 2.Large pony: any pony 48 to 56 inches high
- F Participation - Show management, at county's discretion and in communication with county 4-H staff, may invite participation from enrolled 4-H members outside the county or limit participation to 4-H members from its own county. This should be stated on the entry form.
- G The show arena is off-limits to everyone except working show personnel or during an emergency.
- H Equipment or class rules may be modified or exceptions may be made by show management at their discretion, as needed for the safety of special needs youth or youth needing extra assistance.

Responsibilities of the Judge

- A The Judge must address questions about specific classes or rules to ALL exhibitors, not one-to-one.
- B Each judge should confirm with the show committee or superintendent when questions may be asked and answered, and when an exhibitor may approach the judge. Since judges' decisions are final, they should expect their decisions to be upheld. A judge should be able to provide oral or written comments or clarification to an exhibitor when asked.
- C **The member, horse, and equipment may be inspected at any time during the contest. Members using unsafe and/or illegal equipment may be asked to leave the ring at the judge's discretion.**
- D Judges' decisions are final. A show committee has the option to not rehire a judge who has not met their expectations.



Ribbons and Awards

- A 4-H uses the Danish system of awards, in which every contestant receives an award: a flat blue, red, white, or participation ribbon. Trophies, rosettes, and other special recognition may be awarded in addition.
- B The recommended breakdown for Danish system ribbons in a 100-point score sheet is:
1. Blue award, 85–100 points
 2. Red award, 70–84 points
 3. White award, 69 points and below
- C Disqualified riders may receive a white or participation ribbon.

4-H EQUINE PROGRAM RULEBOOK

- D The system may also be modified in classes that do not follow the same 100-point system or scoring criteria. These classes may include Dressage, Western Dressage, Reining, and Western Games.

GR108 - Competition Divisions

1. Age divisions are based on the youth member's age as of October 1 of the current 4-H program year.
 - A. Juniors ages: 8-10
 - B. Intermediates ages: 11-13
 - C. Seniors ages: 14-18
2. Youth who have reached their 19th birthday before October 1 of the current 4-H year are no longer eligible for membership. For further clarification on age and grade requirements for competition, refer to the Washington State 4-H Program Policy publication (EM0758E).
3. Inter-age competition is not allowed. For example, juniors may not compete against intermediates, or intermediates against seniors.
4. Cloverbuds are youth who have reached their 5th birthday as of October 1 of the current 4-H year through to their 7th birthday. Once they reach 8 years old by October 1st, they become a junior. Cloverbuds may enroll into the Horseless Horse project, but they may have NO contact with horses. Cloverbuds may be evaluated but should not be ranked or placed.

GR109 - Medication and Equine Special Needs

1. The 4-H Horse Program does not tolerate the use of illegal drugs and/or the improper use of animal health products or foreign substances. The administration of any drug or medication that affects the animal's conformation, appearance, natural performance, behavior, or in any way alters its natural color is unacceptable. Extension personnel, 4-H volunteers, families, youth, and show officials have a legal and moral obligation to not misuse these products and to report those that do. The consequences are at the county's discretion.
2. Horses that require any medications or special equipment must have a letter from a licensed veterinarian prior to the 4-H horse event. If a horse requires medication or treatment to protect its health and welfare after the arrival at the show, the medication must be prescribed by a licensed veterinarian. All medication must always be administered according to the prescription specifications or instructions (or both). The exhibitor's parent or legal guardian is responsible and liable for the correct administration of the prescribed drug.



GR110 - Volunteer Policy on Animal Disease Diagnosis and Treatment

1. 4-H volunteers, as representatives of a land-grant university, are expected to act within the policies and guidelines of the 4-H Youth Development Program. A 4-H animal science volunteer may educate members and their families in the normal course of their 4-H activities in the areas of animal care, production, and management. University volunteers are NOT to engage in

4-H EQUINE PROGRAM RULEBOOK

activities that include diagnosis, treatment, or the direct administration of medication to protect animals without authorization from a licensed veterinarian. A 4-H volunteer may exercise commonly accepted first-aid skills and practices in emergency situations.

GR111 - The 4-H Equestrian Headgear Policy

1. 4-H members participating in any 4-H equestrian activity must wear an approved helmet whenever they are mounted on an equine or are in a vehicle (cart, wagon, buggy, etc.) being pulled by an equine. [Approved helmets are optional for In-hand classes](#). An approved helmet meets the minimum performance standards imposed by the American Society for Testing Materials (ASTM) F1163 and includes certification and labeling required by the Safety Equipment Institute (SEI). The helmet must be properly fitted with the harness engaged and properly fastened according to manufacturer's recommendations. It is recommended that 4-H'ers wear their ASTM/SEI helmets any time they are around their horse.

GR112 - Concussion Protocol

1. A 4-H member who is suspected of sustaining a concussion or head injury during 4-H shows, activities, and events shall be removed from the event at that time. Any 4-H member who has been removed from an event as a result of a suspected head injury may not return to participation until the member is evaluated by a licensed health care provider trained in evaluation and management of concussions and received written clearance to return to participation. (RCW 28A.600.190) This concussion protocol statement is directly from the current year WSU 4-H Policy and Procedure Handbook. The policy is in effect for the State 4-H Fair and will be followed.

GR113 - Medals Program

The medals program is optional. The value of a medals program is to establish an educational challenge for advanced riders. Gold, silver, and bronze medals may be awarded to intermediate and senior 4-H youth in a variety of classes, including Western Equitation, English Equitation, Showmanship, Hunt Seat Equitation over Fences, Driving, Trail, Western Games and Dressage.

Medals are awarded on a pass/fail basis. For example, Riders can do a pattern correctly but still not receive a medal if they have done a sloppy pattern or shown poor equitation. Awarding a medal is completely at the judge's discretion. When competing for medals, the exhibitor is riding against a standard of excellence. Sample patterns are available on the [WSU 4-H Animal Science website](#) for counties to use. These patterns are recommended for consistency by the Washington State 4-H Equine Committee.

4-H EQUINE PROGRAM RULEBOOK

CONTEST GUIDELINES

SH – Showmanship

SH101 - Purpose

The purpose of showmanship is to learn courtesy, good grooming, poise, confidence, and how to fit, train, and handle an equine. Showmanship is a demonstration of the member's ability to show the animal, in hand, to its best advantage. Conformation of the animal is not considered. [The equine should also be well-trained to the required routine and well-mannered so that it stands quietly, but alertly, while in the class.](#)

SH102 – Scoring

1. Member
Neat and clean, properly dressed, prompt and alert, confident (poised), courteous.....25%
 2. Animal and equipment
Animal clean and brushed, in good condition, feet cared for. Halter and lead fitted, equipment clean and safe.....25%
 3. Showing the animal
Following directions, leading, turning, standing, backing, stopping, showing to advantage, controlling on lead and in line, attention in line50%
- 100 points total

SH103 – Attire

Attire may be Western, Huntseat, Saddleseat, Dressage, Western Dressage or Driving. Exception - Skirts or dresses are not allowed.

An appropriate hat, helmet or [hunt cap must be worn according to discipline](#). ASTM/SEI helmets, although not required for Showmanship, are encouraged.

Not Allowed

- [Spurs](#)
- [Chaps](#)
- [Whips or crops](#)

SH104 - Equipment

Halter or bridle

A safe, properly fitted halter or bridle complete with a throat latch is required.

- Western must be shown in a halter.
- Hunt Seat, Dressage, and Saddle Seat may be shown in a halter or bridle when appropriate to breed, attire, or both.
- [A breed appropriate halter or In-hand bridle may also be used.](#)

4-H EQUINE PROGRAM RULEBOOK

The halter and lead must be made of leather, leather-like, biothane, rope, or webbing material. [When showing Arabians and Miniature Horses, it is acceptable to use an Arabian/Cable Show Halter.](#) The lead should be 6 to 10 feet (about 2 to 3 meters) long. Be sure the lead is long enough to allow picking up a hind foot.

You may use a bridle when it is appropriate to breed, attire, or both. If you show with a double bridle, you may use either the snaffle or curb reins for leading. The other set of reins is put over the neck near the withers.

Chain with Halter

For safety or control, using a chain under the chin or over the nose is permitted but not required. If used, the chain must be attached and used properly. A chain approximately 15 to 24 inches is long enough. You may run the chain through the ring on the side of the halter or through the ring on the bottom, then over the nose or under the chin to the other side. With a very long chain, you may run the excess up the off cheek; [wrap the chain once around the nose-piece or through the lower ring; and/or](#) it may be doubled back through the bottom ring and snapped back to itself. In all cases, the snap should face out. When leading your horse, do not put your hand on the chain.

SH105 - Grooming Requirements

Horses should be well-groomed and clean. They may be clipped according to breed [or type or](#) left unclipped as a personal choice with no penalties.

SH106 - Class Procedure

The following principles always apply:

1. Individual tests must be performed with the official(s) in the same relative position to each exhibitor.
2. The exhibitor shall not stand directly in front of the horse.
3. Use of the quartering system is required.
4. The exhibitor shall not touch their horse except when executing a requested test that allows touch (for example, sidepass and turn on the forehand) or to smooth the mane or forelock if the judge's inspection has disturbed the grooming. (Tails do not need to be smoothed.)

Exhibitors will be asked to demonstrate their ability to lead, turn, set up, and move their animals as the judge requests. Additional tests, as listed, may be asked.

4-H EQUINE PROGRAM RULEBOOK

SH107 – Tests

Tests **are optional and** must be age/level appropriate for both the horse and rider.

1. Back horse
2. Sidepass. The exhibitor may touch the horse.
3. Turn on haunches (need forward motion)
4. Turn on the forehand (need forward motion). The exhibitor may touch the horse.
5. Lead at the walk or trot from either side
6. Pick up the feet
7. Stop and set up, square and balanced, or according to breed standard. Do not change hands to set up.
8. Answer questions from project materials
9. Perform a circle at a walk or trot

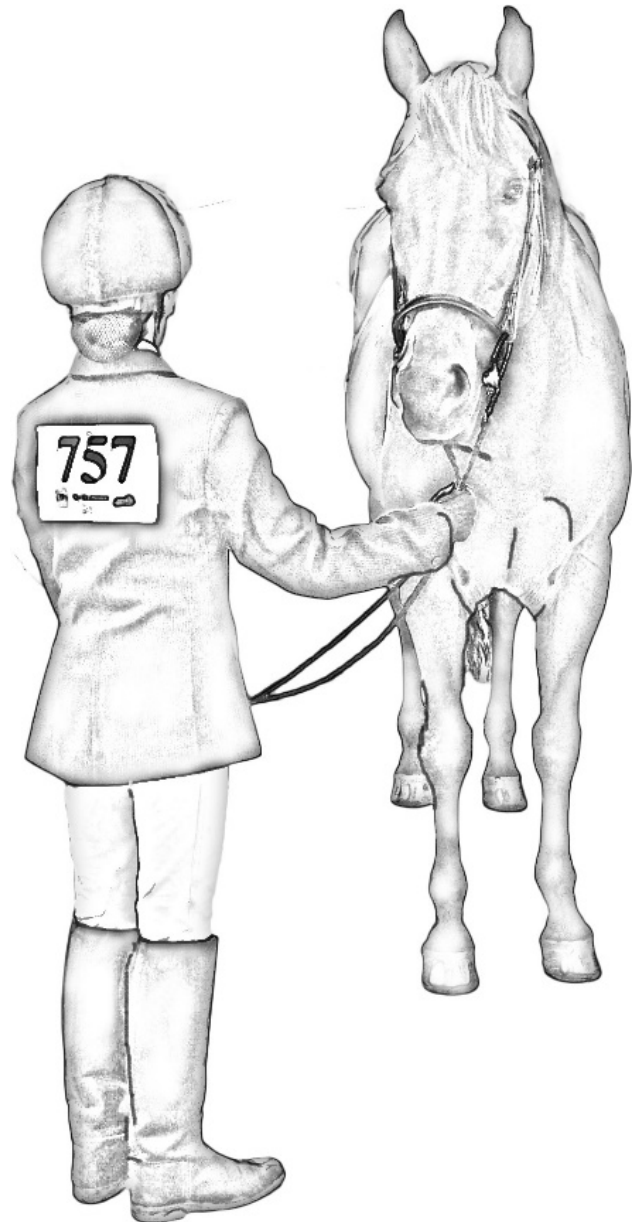

4-H EQUINE PROGRAM RULEBOOK

HEQ - Hunt Seat Equitation

HEQ101 – Purpose

Hunt Seat Equitation is a test of the rider’s skill in an under-saddle class. The horse should respond to what the rider asks with the least possible effort on the part of the rider and least amount of resistance from the horse.

HEQ102 - Scoring

1. Member and appointments
Clothing, equipment, courtesy, poise15%
 2. Seat and hands
Seat, posture, head, legs, hands, balance, distribution of weight, aids.....35%
 3. Performance
Standing, starting, walking, trotting, figure 8 or equivalent at the canter from walk, stopping, turning, backing, general control50%
- 100 points total

[Gaited Horses – Refer to GR106.3](#)

The member will be judged on correct posture, smooth gait transitions, and effective use of aids, with special emphasis on light hands. The performance of the horse is not to be considered more important than the methods used by the rider in obtaining the performance.

HEQ103 – Attire

Required

- Ratcatcher, long-sleeved tailored shirt closed at the neck, or turtleneck shirt. Shirts are tucked in.
- Hunt coat if short-sleeved ratcatcher is worn
- Pants, breeches, or jodhpurs. (White, light or dark colored breeches or jodhpurs are permitted. Bright colors or patterns are not permitted. Contrast piping is allowed)
- Tall hunt boots or jodhpur boots
- ASTM/SEI-approved equestrian helmet

Optional

- Hunt coat (conservative colors)
- Spurs must be English type and used appropriately.
- Half-chaps
- Gloves (any traditional color allowed)
- Pins or ties

HEQ104 - Equipment

Saddle and pad

Required

- Forward seat, close contact, jumping, eventing, or all-purpose English saddle.

Optional

- Saddle pad

[Return to Table of Contents](#)

4-H EQUINE PROGRAM RULEBOOK

Not allowed

- Saddle seat-type English, Dressage, or Western saddle.

Bridle and bit

Required

- English bridle with cavesson.
- Snaffle, pelham, kimberwick, full double bridle, or any other English-type bit appropriate for the seat.

Not allowed

- Dropped, flash, and figure-8 nosebands
- Sidepulls and bit converters
- Double-twisted wire and gag bits

Other tack and equipment

Optional

- Breastplates or breast collars
- Whips or crops - may be no longer than 36 inches

Not allowed

- Martingales of any kind
- Any type of **leg** boot, such as splint boots, bell boots, bandages, and polo wraps.

HEQ105 – Grooming

Hunters are typically shown with forelock, mane and tail braided; however, braiding is optional. If the tail is braided, the mane and forelock must also be braided. The mane and forelock may be braided without the tail being braided. Type of braids is optional. Manes may also be banded. Tails may be banged or left natural.

HEQ106 – Class Procedure

Group classes enter the arena at a walk or trot on the left track and are directed through the required gaits in both ways of the ring at the request of the judge, ring steward or announcer.



[Return to Table of Contents](#)

4-H EQUINE PROGRAM RULEBOOK

HEQ107 – Tests

Tests are optional and must be age/level appropriate for both the horse and rider.

1. Regular or extended walk
2. Regular or extended trot, or intermediate gait.
3. Canter (on the correct lead or a counter canter)
4. Hand gallop.
5. Perform figure 8s, serpentines, circles, straight lines, or other specific patterns at any of the above gaits.
6. Simple or flying lead changes.
7. Ride without irons or stirrups and drop and pick up irons or stirrups.
8. Haunch or forehand turn (need forward motion)
9. Sidepass or two-track
10. Transition from any gait to halt followed by “on the buckle” or loose rein.
11. Change of diagonals
12. Back up
13. Stand for inspection.
14. Balanced stops
15. Answer questions from project materials



[Return to Table of Contents](#)

4-H EQUINE PROGRAM RULEBOOK

HOF - Hunt Seat Equitation Over Fences

HOF101 – Purpose

Equitation Over Fences is a class that tests a rider's ability to control and show a horse over fences. The course typically has at least six jumps. The class's objective is to judge the rider's ability over fences, not the horse's ability.

A horse **must be at least 4** years old before going over jumps.

HOF102 – Scoring

1. Member and appointments

Clothing, equipment, courtesy, poise15%

2. Seat and hands

Seat, posture, head, legs, hands, balance, distribution of weight, aids.....35%

3. Performance

General control, ability to navigate the course with correct strides, and put equine in proper position to jump to the best of their ability meeting fences squarely and at proper distance.....50%

100 points total

The performance begins once the horse enters the ring.

Gaited Horses – Refer to [GR106.3](#)

HOF103 – Attire

Required

- Ratcatcher, long-sleeved tailored shirt closed at the neck, or turtleneck shirt. Shirts are tucked in.
- Pants, breeches, or jodhpurs. (White, light or dark colored breeches or jodhpurs are permitted. Bright colors or patterns are not permitted. Contrast piping is allowed)
- Tall hunt boots or jodhpur boots
- ASTM/SEI-approved equestrian helmet
- Hunt coat if short-sleeved ratcatcher is worn

Optional

- Hunt coat (conservative colors)
- Spurs must be English type and used appropriately.
- Half-chaps
- Gloves (any traditional color allowed)
- Pins or ties

Not allowed

- Spurs in Showmanship, Driving or In-hand Classes

4-H EQUINE PROGRAM RULEBOOK

HOF104 - Equipment

Saddle and pad

Required

- Forward seat, close contact, jumping, eventing, or all purpose English saddle.
- Stirrup safety bars must be in the open position in any Equitation Over Fences class.

Optional

- Saddle pad

Not allowed

- Saddle seat-type English, Dressage, or Western saddle.

Bridle and bit

Required

- English bridle with cavesson.
- Snaffle, pelham, kimberwick, full double bridle, or any other English-type bit appropriate for the seat.

Optional

- Dropped, flash, and figure-8 nosebands

Not allowed

- Sidepulls
- bit converters
- Double-twisted wire or gag bits

Other tack and equipment

Optional

- Breastplates or breast collars
- Martingales (Running martingales may be used only with a snaffle bit)
- Any type of protective leg boots
- Whips or crops may be no longer than 36 inches for hunt seat.

Not allowed

- Hoof boots

HOF105 - Grooming

Refer to [HEQ105 – Grooming](#) above

HOF106 Class Procedure

Safety is paramount. Counties are encouraged to hold introductory level classes such as trot-a-course, in which poles are on the ground; or beginning jumper classes, with jump heights of 18 to 24 inches maximum.

Exhibitors may be asked to perform any test listed under equitation. Performance will be judged on effective use of aids on the entire course. Emphasis will be on light hands, balance, correct posture, and seat on the flat and over fences. Excessive speed will be penalized.

[Return to Table of Contents](#)

4-H EQUINE PROGRAM RULEBOOK

Under the direction of the judge, a safety inspection should be done before riders take any jumps. The inspection will include, but is not limited to, making sure the stirrup bars are open, the stitching on saddle stress points is in good repair, the girth is snug, and the bridle is properly fitted and in good repair.

Maximum recommended jump heights:

- 2' to 2 feet 3 inches for juniors
- 2' 3" to 2 feet 6 inches for intermediates
- 2' 6" to 2 feet 9 inches for seniors

Jump height is not to exceed 3' feet, and the spread is not to exceed the height. All jumping equipment shall be in good working condition and of contrasting color to the ground. No brown or unpainted jump poles, standards, ground poles, or other equipment should be used.

At least one supervised warm-up jump must be available prior to the class. It is preferable that the warm-up jump not be on the course or inside the arena or pattern area. The number of times a competitor can practice a supervised warm-up jump is specified by the show committee.

The course will consist of 6 to 12 jumps, performed at a canter, with at least one change of direction. The judge may ask the class to do rail work at a walk, trot, and canter both ways of the ring.

The rider will be allowed to circle one time before starting the course. A refusal will be called when a horse avoids a jump or stops forward motion. If the refusal is at a combination jump, the rider must retake all elements of the combination. Faults such as knock-downs and touches will not be considered unless they are the fault of the rider.

Types of fences

Required

- Wings at least 12 inches higher than the jumps and 30 inches wide are compulsory when jumps are less than 12 feet wide.
- The distance between standards should be a minimum of 9 feet.
- Ground poles or lines are required.
- Courses should have at least four different types of jumps and one combination jump (24 or 36 feet apart).
- Spreads should not exceed the height of the fence.

Optional

- Basic types of fences are allowed; for example, post and rail, wall, gate, brush, coop, planks, and picket fences.

Not allowed

- In-and-outs are not to be used at the start of the course.
- Triple bars, hogsbacks, targets, square oxers, hinged chicken coops, or any bizarre or dangerous jumps

[Return to Table of Contents](#)

4-H EQUINE PROGRAM RULEBOOK

Major faults

- Refusal(s)
- Loss of stirrup
- Trotting while on course
- Loss of reins
- Excessive speed
- Lack of control

Disqualifications

- Fall of horse or rider
- Three cumulative refusals
- Off course



4-H EQUINE PROGRAM RULEBOOK

SEQ - Saddle Seat Equitation

SEQ101 – Purpose

Saddle Seat Equitation is a test of the rider’s skill in an under-saddle class. The horse should do what the rider asks with the least possible effort on the part of the rider and least amount of resistance from the horse. Saddle Seat horses are often more animated than western or hunters, and this should not distract from the rider's skill.

SEQ102 - Scoring

1. Member and appointments
Clothing, equipment, courtesy, poise15%
 2. Seat and hands
Seat, posture, head, legs, hands, balance, distribution of weight, aids.....35%
 3. Performance
Standing, starting, walking, trotting, figure 8 or equivalent at canter from walk, stopping, turning, backing, general control50%
- 100 points total

Gaited Horses – Refer to [GR106.3](#)

The member will be judged on correct posture, smooth gait transitions, and effective use of aids, with special emphasis on light hands. The performance of the horse is not to be considered more important than the methods used by the rider in obtaining the performance.

The member, horse, and equipment may be inspected at any time during the contest. Members using unsafe equipment may be asked to leave the ring.

SEQ103 - Attire

Required

- Long-sleeved tailored shirt or short-sleeved shirt with a coat
- Tie
- Jodhpur boots (short)
- Pants or Kentucky jodhpurs
- ASTM/SEI-approved equestrian helmet

Optional

- A saddle-seat suit or day coat may be worn, but it must be a conservative color and will not be given preference by the judge.
- Spurs must be English type.
- Whip no longer than 48 inches, including lash
- Gloves
- Four-in-hand or bow tie
- Pin or flower in the lapel

4-H EQUINE PROGRAM RULEBOOK

SEQ104 – Equipment

Saddle

Required

- Saddle seat-type.

Optional

- Saddle Pad
- Breast collars

Not allowed

- Hunt-type, all-purpose, or Western saddles

Bridle and bit(s)

Required

- Full double bridle (curb and bridoon), pelham, or breed-appropriate bit

Not allowed

- Martingales or tie-downs
- Bit Converters

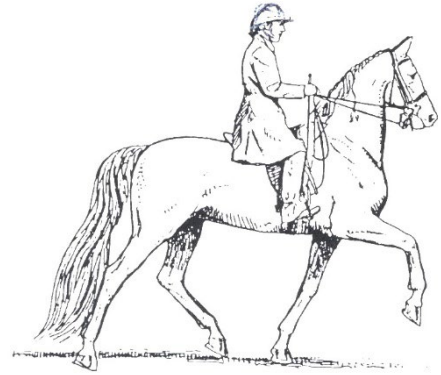

SEQ105 – Grooming

Equines may be shown natural, according to breed type or left unclipped as a personal choice with no penalties.

SEQ106 – Class Procedure

Group Classes enter the arena generally at a trot (may be a walk depending on the judge) on the left track and are directed through the required gaits both ways of the ring at the request of the judge, ring steward or announcer.

SEQ107 – Tests

Tests are optional and must be age/level appropriate for both the horse and rider.

1. Regular or extended walk.
2. Regular or extended trot, or intermediate gait.
3. Canter (on the correct lead)
4. Canter a straight line, on or off the rail, with or without demonstrating a simple change of lead and directed by the judge
5. Perform figure 8's, serpentine, circles, straight lines, or other specific patterns at any of the above gaits.
6. Simple or interrupted lead changes.
7. Ride without stirrups for a brief period of time, at any gait requested (at trot for not more than one minute). Disengage or engage irons at half, walk or any gait requested by the judge.
8. Change of diagonals on or off rail
9. Address or Pick up the reins (only in line)
10. Back (not more than 8 steps)
11. Stand for inspection.
12. Balanced stops

[Return to Table of Contents](#)

4-H EQUINE PROGRAM RULEBOOK

13. Answer questions from project materials
14. Demonstration ride of approximately one minute. Movements must be selected from Tests 1-12 above. The rider will design the pattern and supply a copy to the judge. The ride will be timed and stopped at the end of one minute but the rider will not be penalized for not completing it. Should be used only in Championship and/or Medal Classes.

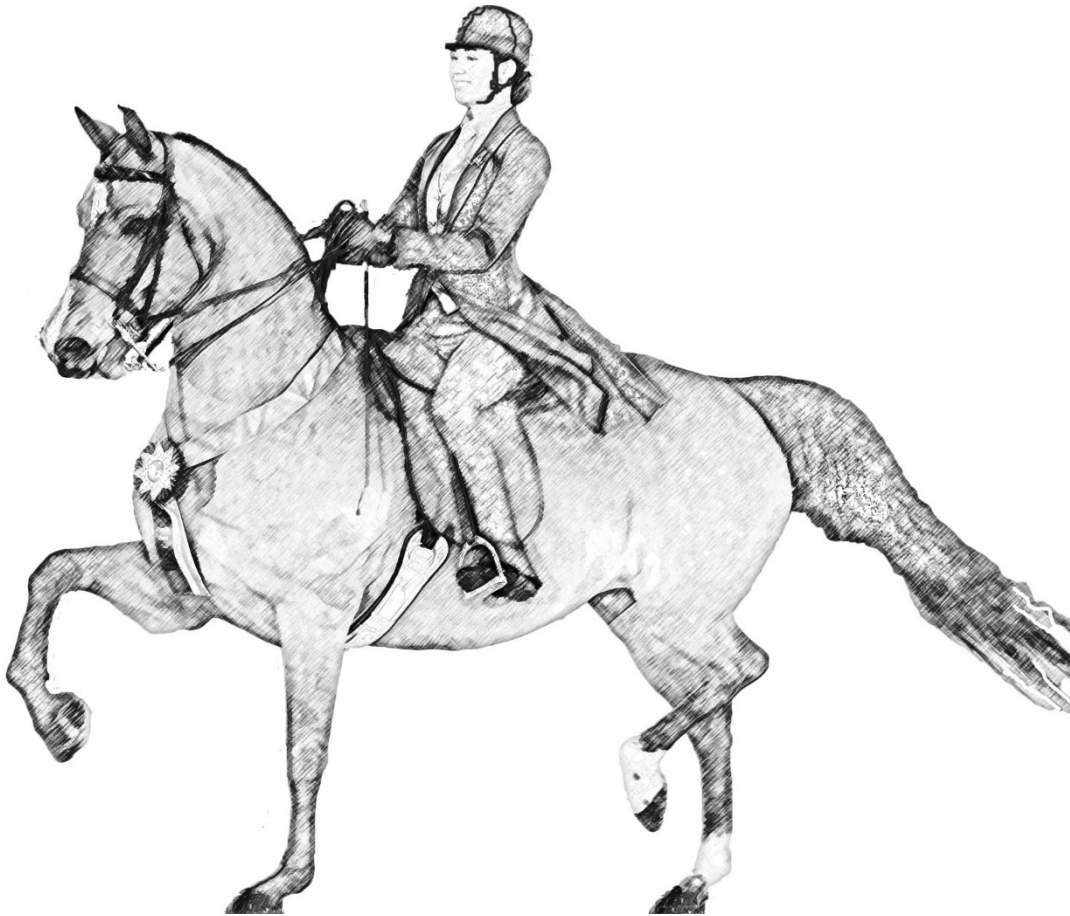

4-H EQUINE PROGRAM RULEBOOK

WEQ - Western Equitation

WEQ101 – Purpose

Western Equitation is a test of the rider’s skill in an under-saddle class. The horse should do what the rider asks with the least possible effort on the part of the rider and least amount of resistance from the horse.

WEQ102 - Scoring

1. Member and appointments
Clothing, equipment, courtesy, poise15%
 2. Seat and hands
Seat, posture, head, legs, hands, balance, distribution of weight, aids.....35%
 3. Performance
Standing, starting, walking, jogging, figure 8 or equivalent at lope from walk, stopping, turning, backing, general control50%
- 100 points total

[Gaited Horses – Refer to GR106.3](#)

The member will be judged on correct posture, smooth gait transitions, and effective use of aids, with special emphasis on light hands. The performance of the horse is not to be considered more important than the methods used by the rider in obtaining the performance.

The member, horse, and equipment may be inspected at any time during the contest. Members using unsafe equipment may be asked to leave the ring.

WEQ103 - Attire

Required

- Long-sleeved Western shirt with any type of collar, tucked in, and sleeves rolled down
- Jeans, trousers, or Western pants
- Belt, unless loops are not present or are covered by another garment.
- Western boots
- ASTM/SEI-approved equestrian helmet

Optional

- Vest, jacket, coat, sweater, jacket with collar
- Gloves
- Ties, pins

Not allowed

- Chaps
- Whips or crops

WEQ104 - Equipment

Saddle and pad

[Return to Table of Contents](#)

4-H EQUINE PROGRAM RULEBOOK

Required

- Any standard Western saddle with a horn may be used, but it must fit the rider and the horse.
- Any clean saddle pad, blanket, or combination is allowed if it provides sufficient padding for horse and rider.
- If the cinch pin or tongue on the cinch is not being used, it must be removed.

Optional

- Back or flank cinch, however, if used, it should be adjusted close to the horse and must be attached to the front cinch with a correctly fitted connecting strap made of a durable material.

Not allowed

- Australian saddles
- Tapaderos (stirrup covers)

Bridle and Bit

Required

- Any Western bridle, including snaffles (refer to snaffles listed as “Not Allowed” below) and bosals, is allowed.

Members showing horses in a snaffle or bosal must have a significantly better performance in order to be placed above a member showing a horse in a curb bit. A curb bit is any leverage bit and should follow guidelines as identified by the United States Equine Federation Manual for western equipment. Horses shown in a snaffle or bosal may be ineligible for top county awards at county discretion.

- Most types of Western bits are acceptable.
- A snaffle must have a curb strap, curb chain, or bit guards. The curb strap or chain is to be attached BELOW the reins on a snaffle bit.
- Overall bit length, as measured in the picture to the right, can be no longer than 8½ inches.
- Curb straps must be plain leather or chains at least ½ inch wide and must lie flat against the jaw.

Optional

- Throatlatches on all bridles are strongly recommended for safety purposes.
- [Slobber Straps with snaffle bits](#)

Not allowed

- Full cheek, half cheek, double wire snaffle or Baucher snaffle bits
- Curb bits with overall bit length longer than 8.5 inches.
- Sidepulls and other bitless bridles.
- Cavessons or nosebands
- Mechanical hackamores
- Slip or gag bits.
- Rolled leather chin/curb straps.

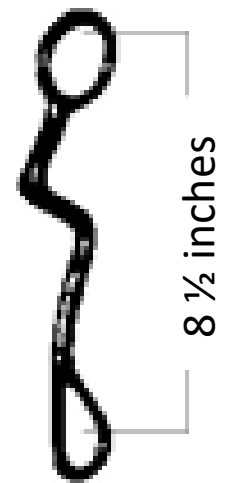

[Return to Table of Contents](#)

4-H EQUINE PROGRAM RULEBOOK

Reins

Only split or romal reins are allowed in Western when using a leverage bit. Split or Mecate Reins are allowed with a snaffle bit or Bosal.

Only one hand may be used when using a Western leverage bit with shanks. The rein hand cannot be changed.

When romal reins are used, no finger between the reins is allowed. In these cases, the romal goes on the opposite side from the rein hand. The rider's hand shall be closed around the reins with the wrist kept straight and relaxed, the thumb on top. The hand holding the excess rein should rest on the thigh with at least 16" of slack between the hands.

There are two ways to hold split reins

1. The same as romal reins, with the free end of the rein (bight) in the opposite hand. No finger between the reins is allowed. In these cases, the romal goes on the opposite side from the rein hand. The rider's hand shall be closed around the reins with the wrist kept straight and relaxed, the thumb on top. The hand holding the excess rein should rest on the thigh with at least 16" of slack between the hands.
2. With the palm of the hand facing down and one finger between the reins. The free end of the rein (bight) falls on the same side as the "rein hand." The position of the hand not being used as the rein hand is optional, but it should be kept free of the horse and equipment and held in a relaxed manner with the elbows close to the body.

When a bosal or snaffle bit is used, two hands must be used. Split reins should be held by crossing the reins between hands so that both hands are holding both reins. Mecate reins are allowed with a bosal. The Mecate tail can be half-hitched around the horn or properly tucked under (not tied to) the rider's belt.

The correct measure of overall bit length is a vertical line from the uppermost part of the headstall slot to the center of the rein ring. 8½" maximum

Other Western tack and equipment

Optional

- Spurs - must be Western type and must be used properly.
- Hobbles
- Lariat or riata
- Breast collars

Not allowed

- Tie-downs, martingales, draw-reins
- Nosebands
- Tack collars
- Leg Boots such as Splint boots, bell boots, bandages, and polo wraps.

4-H EQUINE PROGRAM RULEBOOK

WEQ105 – Grooming

Equines are generally shown with natural manes and tails, although roaching, banding, or pulling of the mane is permissible. Tails may be banded or natural.

WEQ106 – Class Procedure

Group classes enter the arena at a walk or jog on the left track and are directed through the required gaits in both ways of the ring at the request of the judge, ring steward or announcer.

WEQ107 – Tests

Tests are optional and must be age/level appropriate for both the horse and rider.

1. Regular or extended walk
2. Regular or extended jog/trot, or intermediate gait. The rider may sit the extended jog/trot or lean slightly forward, keeping contact with the thighs, with more weight in the stirrups and the seat coming slightly out of the saddle. In either case, the rider must demonstrate an extended gait.
3. Lope (on the correct lead).
4. Extended lope.
5. Perform figure 8s, serpentines, circles, straight lines, or other specific patterns at any of the above gaits.
6. Simple, interrupted, or flying lead changes.
7. Ride without stirrups and drop and pick up stirrups.
8. Haunch or forehand turn (need forward motion).
9. Sidepass.
10. Transition from any gait to halt followed by standing on a loose rein.
11. Back up.
12. Stand for inspection.
13. Rollbacks.
14. Balanced stops.
15. Answer questions from project materials.

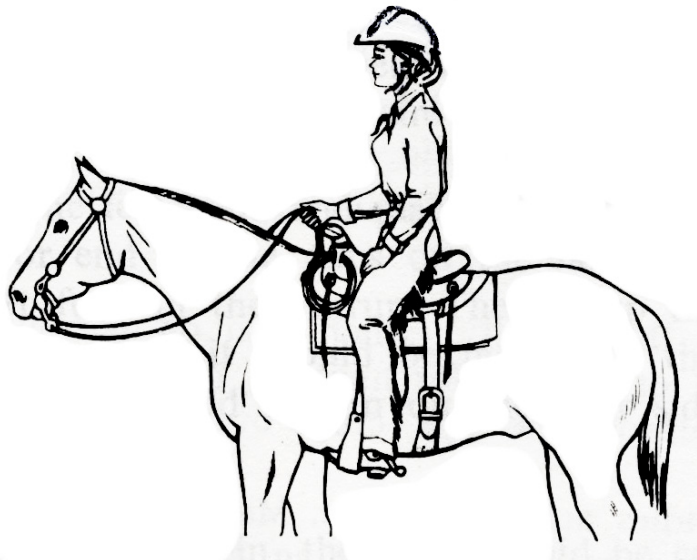

4-H EQUINE PROGRAM RULEBOOK

BEQ - Bareback Equitation

BEQ101 - Purpose

Bareback Equitation is a test of the rider's skill without the assistance of a saddle. Balance is paramount.

BEQ102 - Scoring

1. [Member and appointments](#)

Clothing, equipment, courtesy, poise15%

2. [Seat and hands](#)

Seat, posture, head, legs, hands, balance, distribution of weight, aids.....35%

3. [Performance](#)

Standing, starting, walking, jogging or posting trot, figure 8 or equivalent at lope or canter from walk, stopping, turning, backing, general control50%

100 points total

Gaited Horses – Refer to [GR106.3](#)

BEQ103 - Attire

See appropriate Discipline for attire.

- [HEQ103 - Hunt Seat Equitation Attire](#)
- [SEQ103 - Saddle Seat Equitation Attire](#)
- [WEQ103 - Western Equitation Attire](#)

BEQ104 – Tack

See Appropriate Discipline for bridle/bit requirements.

- [DR104 - Dressage Equipment](#)
- [HEQ104 - Hunt Seat Equitation Equipment](#)
- [SEQ104 - Saddle Seat Equitation Equipment](#)
- [WEQ104 - Western Equitation Equipment](#)

BEQ105 – Grooming

See Appropriate Discipline for Grooming.

- [DR105 - Dressage Grooming](#)
- [HEQ105 - Hunt Seat Equitation Grooming](#)
- [SEQ105 - Saddle Seat Equitation Grooming](#)
- [WEQ105 - Western Equitation Grooming](#)

BEQ106 – Class Procedure

Group classes enter the arena at a walk or jog/trot on the left track and are directed through the required gaits in both ways of the ring at the request of the judge, ring steward or announcer.

[Return to Table of Contents](#)

4-H EQUINE PROGRAM RULEBOOK

Classes may be combined English/Western or preferably divided by discipline.

BEQ107 – Tests

Tests are optional and must be age/level appropriate for both the horse and rider.

- [DR107 - Dressage Tests](#)
- [HEQ107 - Hunt Seat Equitation Tests](#)
- [SEQ107 - Saddle Seat Equitation Tests](#)
- [WEQ105 - Western Equitation Tests](#)

Exhibitors may be asked to perform any test listed under equitation. Western riders must sit the jog or intermediate gait. English riders must post the trot on the correct diagonal. No mount or dismount is allowed.

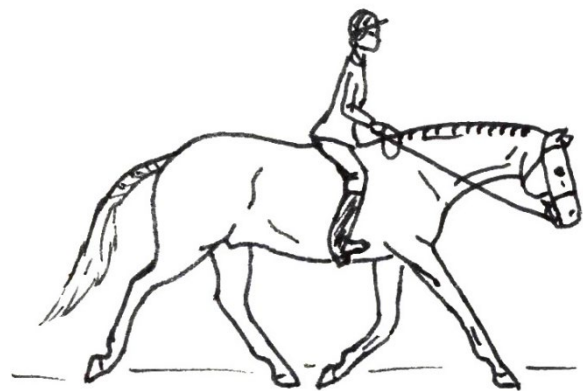
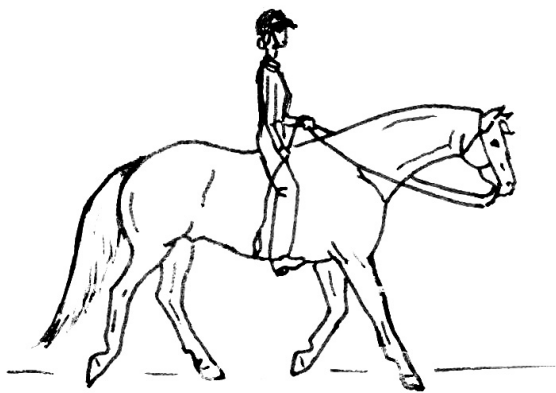
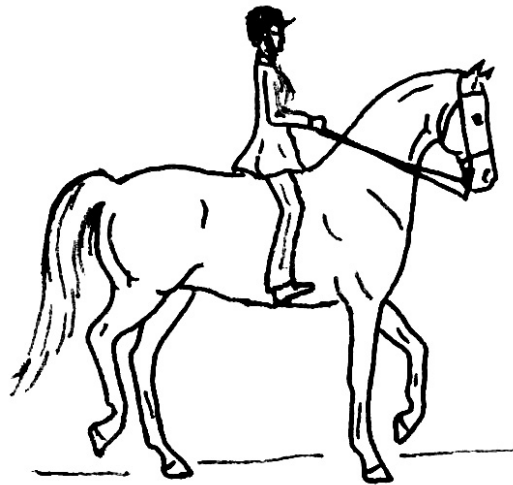

[Return to Table of Contents](#)

4-H EQUINE PROGRAM RULEBOOK

TRR – Trail (**Under Saddle**) Ridden

TRR101 – Purpose

The trail class is an under-saddle mounted test of horse control and the rider's ability to guide the horse through a series of obstacles. The course must be safe for horse and rider. The obstacles may be progressively harder for each age group.

TRR102 - Scoring

Judging is based on safety, performance, way of going, responsiveness, willingness, and general attitude with emphasis on manners. Riders may be asked to move on at the judge's discretion or after three refusals or attempts.

Emphasis is placed on safety, the horse's manners and response to the handler, and the quality of the movement. The exhibitor should be poised, confident, and courteous and should display safe and quiet techniques in handling the horse.

[Gaited Horses – Refer to GR106.3](#)

TRR103 - Attire

Required

- ASTM/SEI helmet
- Either Western or English- See clothing and equipment specifications for attire for each discipline.

Not allowed

- Spurs
- Chaps



TRR104 - Equipment

Refer to each discipline for correct tack

TRR105 – Grooming

[Equines should be groomed according to discipline \(see appropriate division\) or breed type.](#)

TRR106 – Class Procedure

Course

The course will be designed so that exhibitors can move quickly and smoothly between obstacles. The course should contain 6 to 10 obstacles which may be used individually or in combination and should be designed to be completed in less than 5 minutes. Care should be taken so that there is no advantage to either a large or a small horse. The course should be designed to be suitable for all breeds and sizes.

4-H EQUINE PROGRAM RULEBOOK

The course should not be spread out over a very large area; obstacle spacing must allow the horse to move easily between obstacles with no wasted time.

Courses must be posted showing the order and direction of the obstacles. Each disturbed obstacle must be measured and reset for the next rider. See [Table 1](#) for obstacles and suggested spacing.

Unsafe or unnatural obstacles are not permitted, such as stepping into tires, a water box with floating or moving objects, fire extinguishers, or cinder blocks.

Obstacles

When deciding whether the handler should go over obstacles with the horse or work inside poles, boxes, etc., safety should be the primary consideration. This could depend on the size of the horse and the size of the obstacle. The handler must stay out of the danger zone. If there is a definite preference for how an obstacle should be completed, this should be clearly stated in the pattern.

Disqualifications

1. Horse gets loose
2. Extreme disobedience

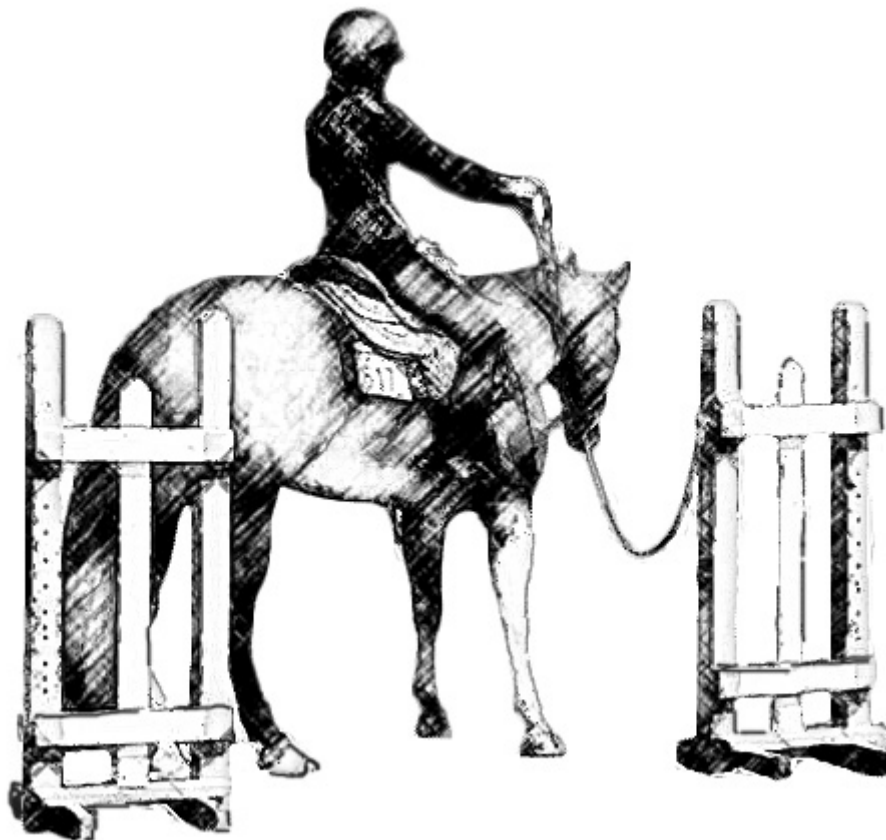

4-H EQUINE PROGRAM RULEBOOK

TRI – Trail In Hand

TRI101 – Purpose

This trail class is an in-hand test of horse control and the handler's ability to guide the horse through a series of obstacles. The course must be safe for horse and handler. The obstacles may be progressively harder for each age group.

The horse must be unsaddled and shown in a safe, properly fitted halter. A chain may be used. Use guidelines for chain use, touching the horse, and halter and lead from showmanship class expectations on [SH104 Showmanship Equipment](#)

TRI102 - Scoring

Judging is based on safety, performance, way of going, responsiveness, willingness, and general attitude with emphasis on manners. Handlers may be asked to move on at the judge's discretion or after three refusals or attempts.

Emphasis is placed on safety, the horse's manners and response to the handler, and the quality of the movement. The exhibitor should be poised, confident, and courteous and should display safe and quiet techniques in handling the horse.

[Gaited Horses – Refer to GR106.3](#)

TRI103 - Attire

Required

- Either Western, English, or Driving Attire ([No Skirts or Dresses](#)). See clothing and equipment specifications for proper attire.

Optional

- [ASTM/SEI helmet](#)

Not allowed

- Spurs
- Chaps
- No Skirts or Dresses



TRI104 - Equipment

Required

- Halter with throatlatch and a lead line, suitable for the horse

Optional

- Correctly attached chain, only if used properly ([see SH104 - Showmanship Equipment](#))
- Boots, bandages, or both on the horse

Not allowed

- Bridles
- Whips or crops
- [Saddles](#)

[Return to Table of Contents](#)

4-H EQUINE PROGRAM RULEBOOK

TRI105 – Grooming

Equines should be groomed according to discipline (see appropriate division) or breed type.

TRI106 – Class Procedure

Course

The course will be designed so that exhibitors can move quickly and smoothly between obstacles. The course should contain 6 to 10 obstacles which may be used individually or in combination and should be designed to be completed in less than 5 minutes. Care should be taken so that there is no advantage to either a large or a small horse. The course should be designed to be suitable for all breeds and sizes.

The course should not be spread out over a very large area; obstacle spacing must allow the horse to move easily between obstacles with no wasted time.

Courses must be posted showing the order and direction of the obstacles. Each disturbed obstacle must be measured and reset for the next rider. See Table 1 for obstacles and suggested spacing.

Unsafe or unnatural obstacles are not permitted, such as stepping into tires, a water box with floating or moving objects, fire extinguishers, or cinder blocks.

Obstacles

Obstacles can be generally the same as for a standard trail class, except lope/canter obstacles are not allowed.

When deciding whether the handler should go over obstacles with the horse or work inside poles, boxes, etc., safety should be the primary consideration. This could depend on the size of the horse and the size of the obstacle. The handler must stay out of the danger zone.

If there is a definite preference for how an obstacle should be completed, this should be clearly stated in the pattern.

Basis for judging

Emphasis is placed on safety, the horse's manners and response to the handler, and the quality of the movement. The exhibitor should be poised, confident, and courteous and should display safe and quiet techniques in handling the horse. Handlers may be asked to move on after three refusals or at the judge's discretion.

Disqualifications

1. Horse gets loose
2. Extreme disobedience

4-H EQUINE PROGRAM RULEBOOK

Table 1 - Mandatory dimensions of trail obstacles

	Measurements are made from center of pole to center of pole.	
	Mounted	In-Hand
Walk Trot Lope-Overs	Maximum height 10 in. 20–24 in. apart for walkover 3–3½ ft. apart for the jog 6–7 ft. apart for the lope/canter Spoke style should be set 24 in. apart halfway. No freely rolling poles allowed	20–24 in. apart for walkover 3 ft. apart for trot overs 10 in. maximum height
Backthroughs	Minimum of 28 in. wide on ground Minimum of 30 in. wide elevated Minimum of 32 in. wide for barrels or cones	On ground only 36-in. minimum width if handler is inside poles
Sidepass	Minimum of 24 in. between poles Maximum height of 24 in.	Minimum of 30 in. between poles On ground only
Serpentines	Cones minimum 6 ft. apart Guardrails (if used) 3 ft. to either side Cones minimum 3 ft. apart Guardrails (if used) 6–8 ft. to either side If tall standards are used, dimensions can be looser.	Cones minimum 4 ft. apart for walk Guardrails (if used) minimum of 4 ft. from cones Cones minimum 7 ft. apart for trot Guardrails (if used) minimum of 4 ft. from cones
Gate	Latch 54–60 in. high Minimum of 4 ft. wide Rope gate optional	Minimum 4 ft. wide Rope gate optional
Jump	Maximum height 16 in.	Maximum height 16 in. Minimum width between standards 12 ft.
Bridge or Plank	Must lie flat on ground Minimum of 12 in. wide for a plank Minimum of 36 in. wide for a bridge	Must lie flat on ground Not to exceed 12 in. high Minimum 48 in. wide if handler to be on the bridge
Ground Tie or Hobble	Inside a minimum 6-ft.-diameter circle	Inside a minimum 6-ft.-diameter circle
Mailbox	Must be a minimum of 48 in. from the ground to the bottom of the mailbox	Must be a minimum of 48 in. from the ground to the bottom of the mailbox
Turn in Box	Minimum 6-ft. sides	Minimum 8-ft. sides
Other obstacles you may want to consider	Tie horse properly, pick up horse's feet, carry item, dismount and mount (juniors will not be asked to mount), walk through brush, walk by a hide or noisy object.	Tie horse properly, pick up feet, walk by a hide or noisy object
Obstacles not allowed	Tires, walking on plastic, cinder blocks, fire extinguishers, water boxes with floating or moving objects, PVC pipe, live animals, wire gates, unsafe or unnatural obstacles	Tires, walking on plastic, cinder blocks, fire extinguishers, water boxes with floating or moving objects, PVC pipe, live animals, wire gates, unsafe or unnatural obstacles

4-H EQUINE PROGRAM RULEBOOK

WG – Western Games

WG101 - Purpose

Western Games provides an educational opportunity in which youth demonstrate their ability to safely navigate a prescribed course in the fastest time possible. Events are timed games on horseback and are individual in nature.

4-H Western Games require the humane treatment of all animals entered in state and county competitions. Exhibitors are expected to treat their animals with respect and provide for the animal's continuous well-being through proper feeding, handling, disease prevention, sanitation, and attention to the animal's safety. Officials should be prepared to dismiss any exhibitor who abuses or mistreats their animal.

Horsemanship, sportsmanship, and safety will be stressed in all Western gaming classes. The safety of the exhibitors, horses, and volunteers is the most important aspect of the program.

Approved events include:

- Figure 8 Stake Race
- Idaho Figure 8
- Pole Bending
- Key Race
- Barrels
- Keyhole Race
- Two-Barrel Flag Race
- NSCA (International) Flag Race

Counties may run other individual events as long as they are as safe or safer, they have rules from a recognized gaming organization, and the county educator and state staff person agree in advance. Usually, team events are not appropriate. Rodeo, racing, and bareback gaming events are prohibited.

Exhibitors may be asked to submit to a close inspection before any event. The purpose of the close inspection is to demonstrate an exhibitor's ability to handle and control his or her horse in a safe manner. The close inspection also provides the show management with an opportunity to examine the exhibitor's tack and equipment. Exhibitors failing the close inspection will not be allowed to make their scheduled run in that event.

WG102 - Scoring

Scores are the actual times in which an event is successfully completed with any time penalties added.

Participants are timed, then arranged in numerical rank order, and then divided into predetermined blue, red, and white ribbon groups. This system is referred to as the modified merit system of judging. Individuals receive a basic score equivalent to the number of seconds

4-H EQUINE PROGRAM RULEBOOK

(to the nearest thousandth) that it takes to complete the event. Penalty points are added to this score. Counties have the option of determining their own method of awarding Danish ribbons.

Recommended Awards

The Danish system of awarding ribbons is recommended for Western Games. Counties may also use the American placing of ribbons (1st, 2nd, 3rd, etc.) in addition to the Danish awards. The awarding of ribbons is based on the rider's time in each event.

Disqualified riders receive white ribbons, participation ribbons, or no award.

General Rules

Riders may hold onto the saddle horn. Two hands may be used on the reins and hands may be changed. Riders must wear their exhibitor number on their back or both sides of their horse at all times while mounted.

WG103 - Attire

Required

- Long-sleeved Western shirt with any type of collar, tucked in, and sleeves rolled down
- Jeans, trousers, or Western pants
- Western boots
- ASTM/SEI-approved equestrian helmet

Optional

- Belt, unless loops are not present or are covered by another garment.
- Vest, jacket, coat, sweater, jacket with collar
- Gloves
- Ties, pins
- Whips or crops



WG104 - Equipment

Required

- Western saddle with a saddle horn
- Throatlatch on the bridle
- Curb strap on all bits
- Roping or single piece reins

[Return to Table of Contents](#)

4-H EQUINE PROGRAM RULEBOOK

Optional

- [Martingales](#) (Running martingales may be used only with a snaffle bit but must have rein stops [and be behind or attached to the breast collar](#))
- Breast collar
- Tie-downs attached to a breast collar
- Nosebands
- Draw reins
- Splint boots, bell boots, or bandages
- Gag bits
- Whips under 36 inches, bats, or quirts

Not allowed

- Mecate reins
- Tied split reins
- Buckled reins
- [Hoof Boots](#)

Riders will be disqualified if the judge considers equipment inhumane or dangerous, or if equipment breaks and the rider is unable to safely continue without repairs.

Bats, spurs, and over-and-unders will be open to inspection by the judges. Spurs, if worn, must be Western type and used properly. Should these properties be found to be abusive by nature (such as pronged, weighted, or cutting), they shall be banned from use. No warning will be required.

Gaming equipment

Plastic 55-gallon barrels are recommended. Eight to 12 pounds of water or clean, dry sand is recommended as an appropriate filler material. Metal barrels are strongly discouraged. If no other alternative exists, metal barrels must have a protective material (such as a rubber bicycle tire) placed around the upper, outermost portion of the rim where the barrel could come into contact with the rider's lower leg.

Poles must be 1 to 1½ inches in diameter and 75 to 85 inches tall. Poles may be white or striped, depending on the event and situation. If striped poles are used, they must have two stripes, each 3 inches wide. The first stripe is 1 foot from the top, and the second stripe is 1 foot from the bottom of the first stripe. All poles must be made of material that will not splinter, such as schedule 40 to 80 plastic pipe (schedule 80 pipe is the most durable). Pole bases, weighing approximately 14 pounds, should be 6 inches tall, 14 inches across, and made of black rubber. The total weight of the pole and base should be approximately 16 pounds.

An electronic timer and reader board are recommended. At county qualifying gaming competitions, if an electronic timer is not available, a hand-held stopwatch that measures times to the nearest hundredth of a second should be stationed at the start and finish lines of each game.

4-H EQUINE PROGRAM RULEBOOK

Ties

The recommended procedure for breaking ties is a runoff or toss of a coin. When breaking a tie with a runoff, the rider with the slower time takes the next lower position. If there is still a disagreement, the judge's decision is final.

Mounted riders

Riders are considered mounted when their knee is over the center line of the horse's back. Riders must remain mounted until the judge's final acknowledgment.

Re-rides

Re-rides are run after the last rider in that event. Penalties do not carry over from the original ride.

Acceptable reasons for re-rides:

- Timing device failure
- Course obstruction as determined by the judge
- Course measured incorrectly

Unacceptable reasons for re-rides:

- Horse or rider damage to arena equipment
- Failure of tack or participant's equipment
- Horse or rider accident or injury

Lane lines

When more than one course is in use, lane lines are required for safety. Courses are to be centered within each lane. At times, lane lines may not be used because of time constraints or arena size is not conducive for safety.

Run-out box

A run-out box may be used. The box size is generally 60 to 80 feet long, but it may be modified for safety or arena configuration. [If a run-out box is used, failure to remain within the designated lane and/or runout box until the judge's final acknowledgement will constitute a disqualification.](#)

[A rider will be deemed outside of their lane and/or run-out box should all four of the horse's feet cross over a line at the same time.](#)

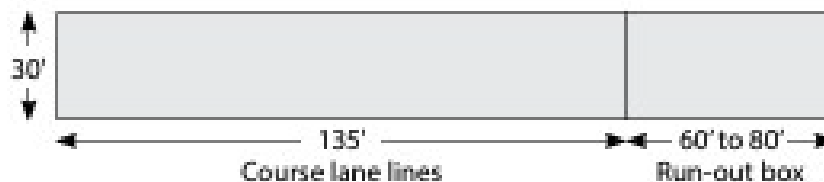

Moving a course

If a course is moved for safety reasons, riders may choose to re-ride or keep their first time. If the course is moved because of an initial wrong measurement, all riders must re-ride.

4-H EQUINE PROGRAM RULEBOOK

Acknowledging the judge

Riders MUST acknowledge the judge before starting and after completing the course. Protocol for acknowledging the judge is as follows:

- At the start, the rider must control the horse and wait for the judge's signal to begin.
- Before the exit, the rider must have the horse under control, be mounted, face the judge, and wait for the judge's signal to exit.

Arena safety

- During the running of any event, all arena gates must be closed.
- Contestants must enter the arena mounted in a controlled, safe manner, and may leave the arena only after the judge's final acknowledgment. If the rider dismounts, after the judge's acknowledgment, the exhibitor may dismount, take the reins off the neck for safety, and exit.
- It is recommended that only one horse be in the arena at a time.
- Only contestants, ring crew, and officials are allowed in the arena.
- Horses that constitute a safety hazard may be disqualified.
- In all events, the ring crew may reset downed equipment or repair lines after a rider has completed the course.
- Riders must enter the arena without assistance from anyone other than one or more 4-H members who are also mounted.
- Raking will be done as needed but must be consistent within each age division.

Coaching

Coaching as defined by show management and at the judge's discretion is not allowed. It is inappropriate for ring help, announcer, timers, etc., to coach, or comment to or about exhibitors on the course.

Course

- A white line should be used to mark lane lines, a run-out box, and the keyhole.
- Two poles or cones, 30 feet apart (60 feet apart in the case of barrels), designate the start–finish line. A horse must pass between these poles or cones at the start and finish of each event.
- Course measurement is made from the center of the poles, barrels, containers, or other arena equipment.
- Timers are placed on the start–finish line.

Penalties and general disqualifications

There will be a 5-second penalty for each stake, pole, barrel, or small container knocked down. Intentionally righting a pole or barrel is allowed with no penalty.

4-H EQUINE PROGRAM RULEBOOK

Disqualifications include the following:

1. Failure to enter the arena mounted
 2. Entering the arena with the assistance of anyone other than another mounted 4-H member
 3. Failure to cross the start line within 60 seconds from the time the gate opens
 4. Upsetting the start–finish markers
 5. Crossing the start–finish line outside of the start–finish line markers
 6. Crossing the start–finish line (breaking the barrier) with any part of the horse or rider (outside of the customary start and finish)
 7. Run-outs
 8. Refusals (a balk is not considered a refusal if the horse finally finishes the course correctly)
 9. Leaving the course Determined at judge’s discretion
 10. Dismounting at any time while on course
 11. Failure to follow the pattern for the event
 12. Passing any obstacle completely on the wrong side
 13. Circling any obstacle while on course, except flag races and other container events. [Riders may be asked to move on at the judge’s discretion or after three refusals or attempts.](#)
 14. Failure to remain within designated lane and/or runout box until judge’s final acknowledgement will constitute a disqualification. A rider will be deemed outside of their lane and/or run-out box should all four of the horse’s feet cross over a line at the same time.
 15. A horse being unruly or out of control
 16. Spurring or striking the horse in front of the cinch. Youth are allowed to pet their horse in front of the cinch in a humane way, as perceived by the judge. Spurring, striking, (e.g., hitting or slapping) can be considered disqualification.
 17. Striking the horse with arena equipment
 18. Using rubber bands or anything else to anchor the rider to the horse or saddle
 19. Failure to acknowledge the judge before and after the run
- Show management or the judge may disqualify a rider for unsportsmanlike conduct, profanity, unnecessary roughness, abusing the horse, or disorderly conduct of any kind. The judge may also disqualify an unmanageable horse for reasons of safety or the exhibitor’s inability to handle or control it.

WG105 – Grooming









[Horses should be well-groomed, clean, and clipped according to breed or may be left natural, for example unclipped bridle path, tactile hair around eyes and muzzle, fetlock, as a personal choice with no penalty. Exhibitors may decorate their horse with glitter, paint, or other means as long as it is considered safe and humane.](#)

WG106 Class Procedure

[All Western Games Events are generally individual, however, there may be multiple lanes running simultaneously when the arena size and the event allow.](#)

4-H EQUINE PROGRAM RULEBOOK

Table 2. Judges' Hand Signals

		
Course is ready: Hold up flag	General disqualification: Thumb extended over shoulder	Failure to start on time: Point to wristwatch
		
Striking ahead of cinch: Jab thumb into side	Leaving the course: Horizontal circular motion	Striking the horse with arena equipment: Slap thigh
		
5-second penalty: Hand raised with five fingers extended. Repeat to show 10, 15, or more seconds.	Safe or clean run: Both hands, palms down and extended arm's length in front with a back-and-forth motion	Unnecessary roughness or abusing the horse: Both thumbs to the ribs

4-H EQUINE PROGRAM RULEBOOK

Description of Approved Events

Figure 8 Stake Race

Two poles are set 120 feet apart at opposite ends of the course, and two center poles set 30 feet apart at a point halfway between the two end poles. The two center poles mark the start–finish line. The rider starts between the two center poles and runs a figure 8 around the two end poles, with the first turn being optional. Riders may start from either end of the course, but they may NOT turn a pole on the course before crossing the start line. There is a 5-second penalty for each pole knocked down.

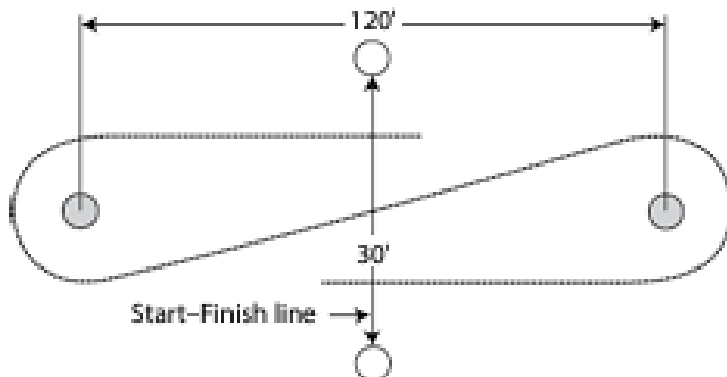

Idaho Figure 8

Two poles are set 100 feet apart, the first set 20 feet from the start–finish line; the second, 120 feet from the same line.

The rider crosses the start line, rides down the side of the course (side optional) to pole B, turns pole B, rides to pole A, turns pole A in the opposite direction, rides back to pole B, turns pole B in the opposite direction of A, and rides across the finish line, completing a figure 8 pattern.

Riders must remain in designated lanes.

There is a 5-second penalty for each pole knocked over. Turning a pole the wrong direction is considered off course.

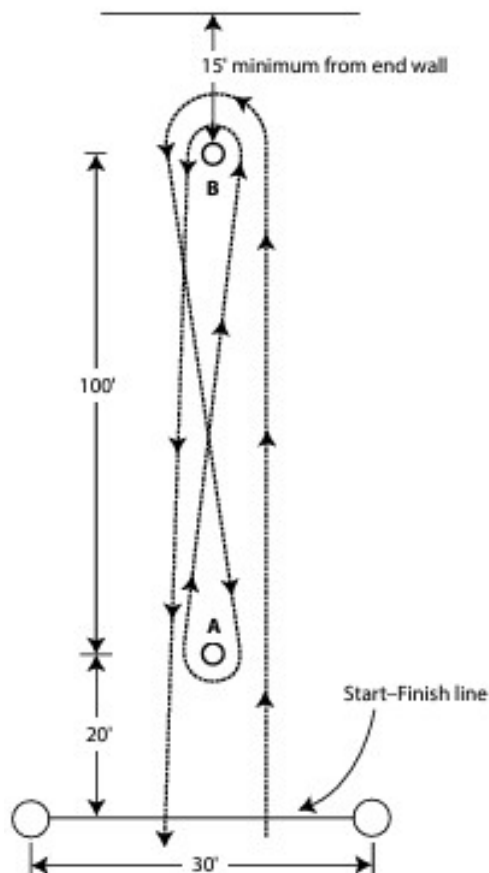

4-H EQUINE PROGRAM RULEBOOK

Pole Bending

Six poles are set in a straight line, each spaced 21 feet apart with the start–finish line 21 feet in front of the first pole.

The rider crosses the start line, travels to pole number 6, turns, weaves back through the poles to number 1, turns, weaves back through the poles to number 6, turns and travels across the finish line.

There is a 5-second penalty for each pole knocked over.

Poles will not be reset during the run.

Riders must remain in their designated lanes.

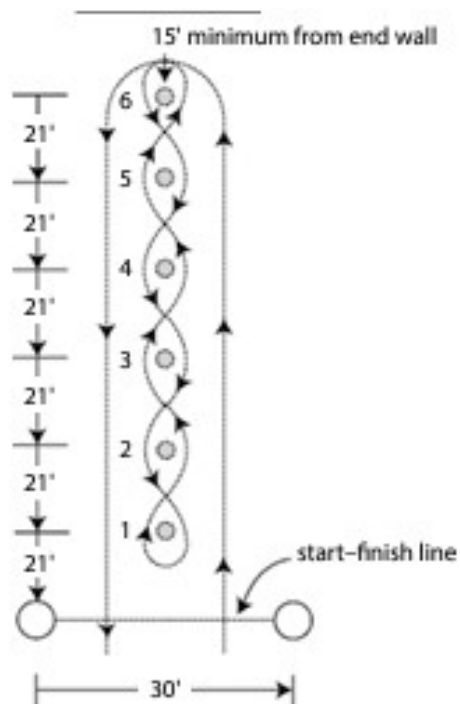

Key Race

Four white poles, striped or covered with a 48-inch red sleeve, are placed 5 feet apart at marks 110 and 120 feet from the start–finish line.

The rider travels down, passing completely between both sets of poles (as diagramed), turns, reverses course back between both sets of poles, and crosses the finish line.

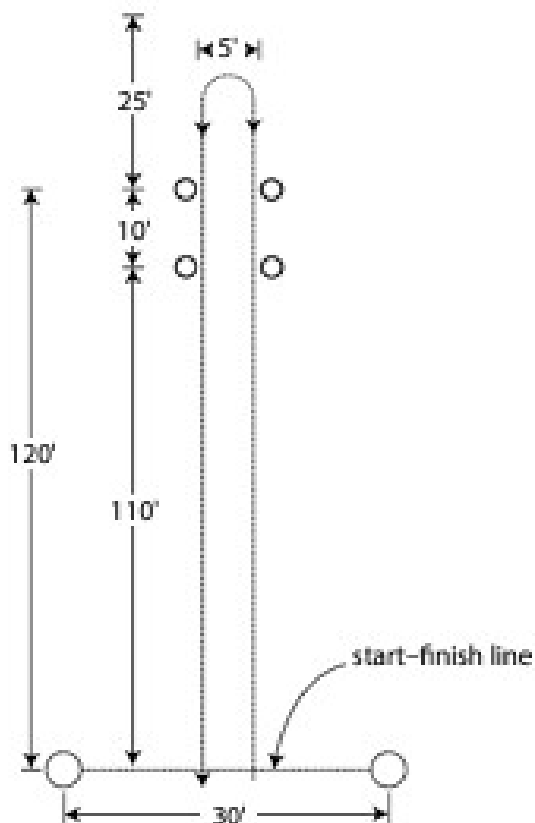

4-H EQUINE PROGRAM RULEBOOK

Barrels

Three barrels are placed in a triangular formation. For the 75-foot course, the No. 1 and No. 2 barrels are set 30 feet from the start-finish line and 75 feet apart. The No. 3 barrel is 75 feet from the No. 1 and No. 2 barrels.

The rider crosses the 60-foot start line, circles the No. 1 barrel to the right, crosses to the No. 2 barrel, circles it to the left, rides to the No. 3 barrel, circles it to the left, and travels across the finish line. The rider may alternatively cross the starting line to the No. 2 barrel, circle it to the left, cross to the No. 1 barrel, circle it to the right, run to the No. 3 barrel, circle it to the right, and proceed across the finish line.

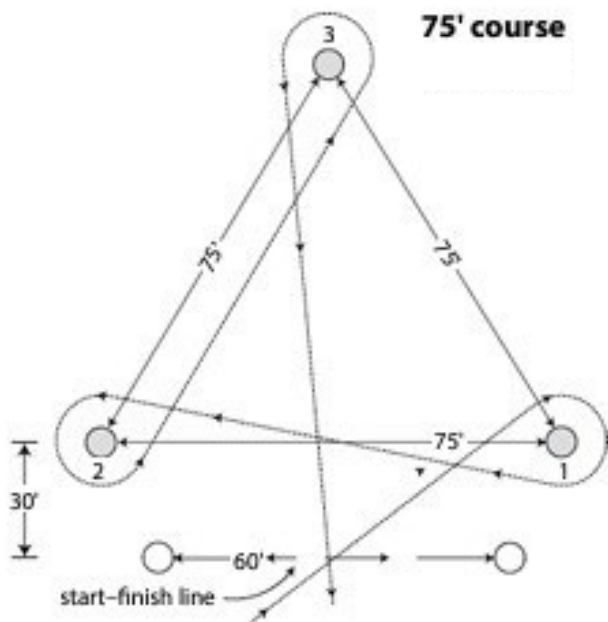

Keyhole Race

The rider crosses the start-finish line, travels 100 feet into a 20-foot-diameter keyhole marked with a white line, turns the horse, and returns across the start-finish line. All four of the horse's feet must stay within the keyhole.

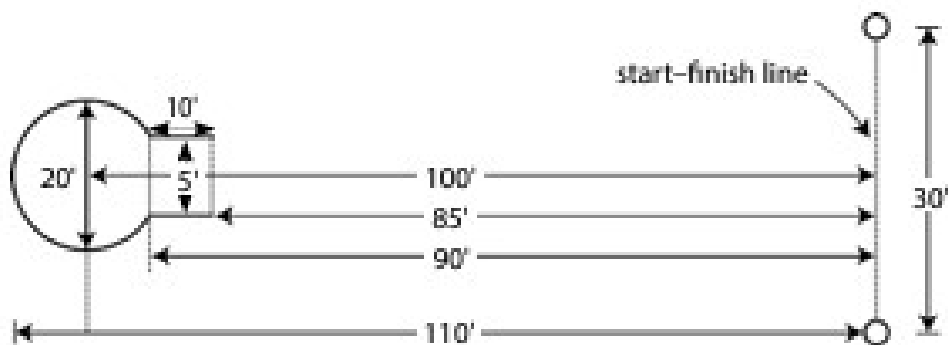

[Return to Table of Contents](#)

4-H EQUINE PROGRAM RULEBOOK

Two-Barrel Flag Race

Two metal quarter barrels (14 inches in diameter and 27 inches high) are set 100 feet apart, with the first barrel 20 feet from the start–finish line. The bottom of each barrel has 8 to 10 inches of sand or soft dirt. The two staffs should be wooden dowels of minimum 1-inch and maximum 1 1/16-inch diameter, 5 feet long, and painted white. Flags should be of sturdy cotton, hemmed to 8 by 12 inches, one white and one dark. Each flag should be wrapped completely around a staff and tacked securely, leaving an 8- by 8-inch portion free from the staff.

The rider crosses the start–finish line, rides to container A (side optional), and takes the flag; then, while riding around container B, the rider places the container A flag into container B and picks up the container B flag; the rider then puts the container B flag into container A as they pass; the rider finishes by crossing the start–finish line.

- Riders must designate the flag positions before starting the course.
- Riders may circle the barrel more than once, but there must be continuous forward motion. **Riders shall be asked to move on at the judge's discretion or after three refusals or attempts.**
- A 5-second penalty is added for each knock-down of a container, dropped flag, or missed container.
- A 10-second penalty is added for failure to pick up the flag from the barrel.
- If the rider carries the flag across the finish line, it is a disqualification.
- Riders may cross over between barrels B and A.
- Riders must break the plane (go around the far side) of the 2nd barrel when picking up the flag.

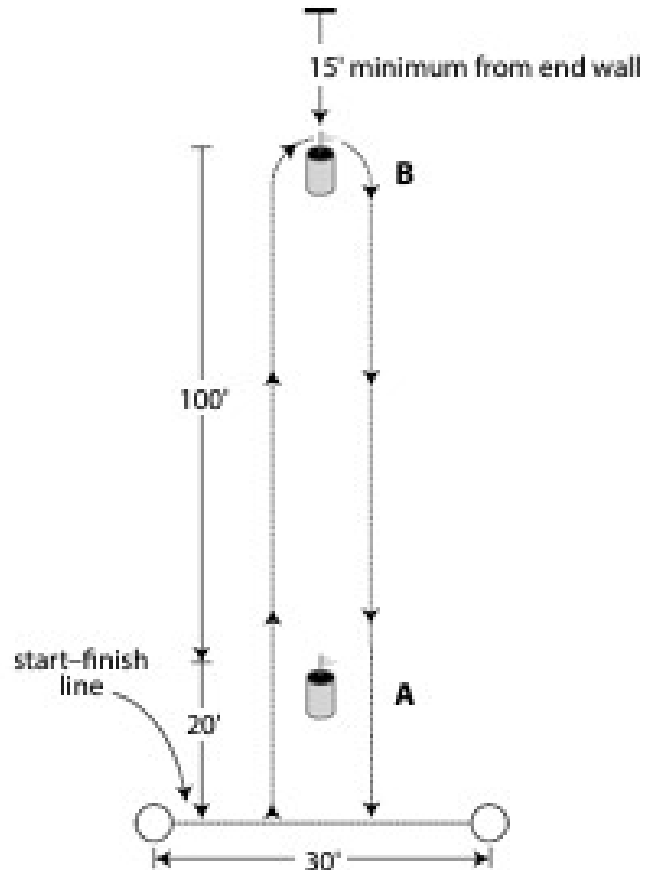

4-H EQUINE PROGRAM RULEBOOK

International Flag Race

- A barrel is set 120 feet from the start–finish line.
- Centered on top of the barrel is a **sturdy round container without a handle, that is** approximately 6 3/16 inches in diameter and 7 inches high filled ¾ full of sand or soil.
- Stand the flag straight up in the sand or soil.
- A round dowel 14 inches long and a minimum of 7/8 inch in diameter is placed in the can with a flag wrapped and tacked so that a 4-inch square is free.

The rider crosses the start–finish line, goes down and around the barrel in either direction, picks up the flag, and carries the flag back across the start–finish line.

- Knocking over the can is a 5-second penalty.
- Knocking over a can and barrel is a 10-second penalty.
- Dropping the flag before crossing the finish line is a disqualification.

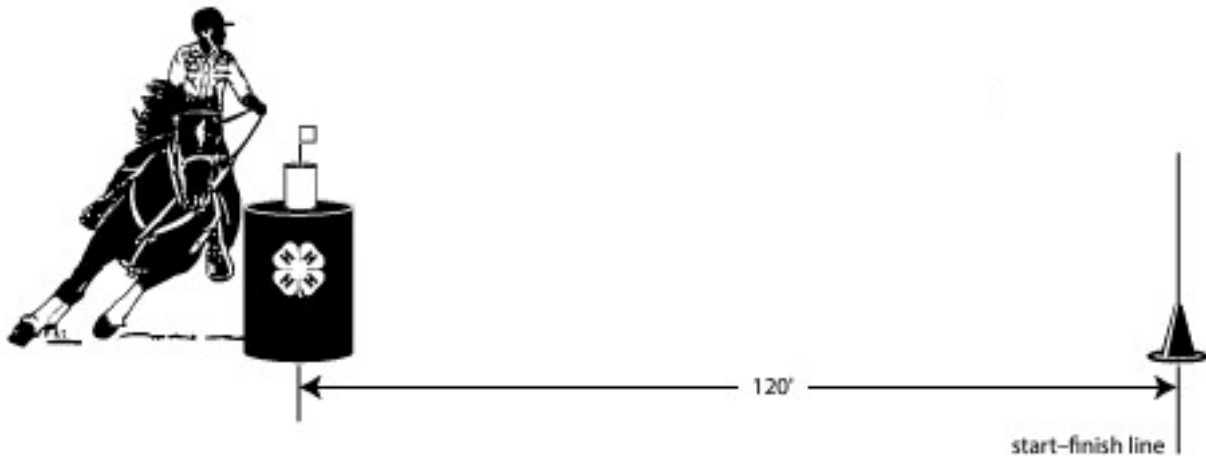

4-H EQUINE PROGRAM RULEBOOK

DR – Dressage (English)

DR101 – Purpose

Dressage is all about the rider working in harmony with their horse, developing suppleness, flexibility, obedience, and athleticism – which ultimately helps make a horse more pleasant to ride.

DR102 – Scoring

In a dressage test, the rider and horse perform certain movements specific to the level at which they are competing. Each of these movements is scored out of 10 by the judge, who is seated at "C" just outside the arena. Some particularly difficult movements receive double marks, and the rider's skill is also marked. The total marks are then converted into a percentage score for the combination – the higher the better.

A ride is to be judged on the horse's gait, impulsion, and submission; the rider's position and seat; and the correctness and effectiveness of the aids. Each movement is scored (0 to 10 points) to establish whether it was insufficient (4 or below) or sufficient (5 or above).

Additional information on how to ride the test and how the test is to be judged can be found in the 4-H Dressage Manual (PNW 608).

The use of the voice in any way whatsoever or clicking the tongue once or repeatedly is a fault involving the deduction of 2 marks from those that would otherwise have been awarded for the movement where this occurred.

Gaited Horses – Refer to [GR106.3](#)

DR103 - Attire

Required

- Ratcatcher, long-sleeved tailored shirt closed at the neck, or turtleneck shirt. Shirts are tucked in.
- Hunt coat if short-sleeved ratcatcher is worn
- Pants, breeches, or jodhpurs. (White, light or dark colored breeches or jodhpurs are permitted. Bright colors or patterns are not permitted. Contrast piping is allowed)
- Tall hunt boots or jodhpur boots
- ASTM/SEI-approved equestrian helmet

Optional

- Hunt coat (conservative colors)
- Spurs must be English type and used appropriately. Rowels must be blunt and smooth and free to rotate.
- Half-chaps
- Gloves (any traditional color allowed)
- Pins or ties

[Return to Table of Contents](#)

4-H EQUINE PROGRAM RULEBOOK

DR104 - Equipment

Saddles and pads

Required

- Dressage, Forward seat, close contact or jumping saddle

Optional

- Saddle pad

Not allowed

- Saddle seat-type English saddle or a Western saddle

Bridle and bit

Required

- English bridle made entirely of leather or leather-like material (except for buckles)
- English bridle with cavesson
- Plain, smooth snaffle bit in Introductory through 2nd levels. For appropriate bits for 3rd level and up, refer to USEF dressage rules. See the 4-H Dressage Manual (PNW 608) for types of acceptable bits.
- The mouthpiece of any bit must be metal or rigid plastic and may be covered with rubber.

Optional

- Dropped, flash, and figure-8 nosebands are allowed in Dressage and Hunt Seat Equitation over Fences, but no other flat classes.

Not allowed

- Flexible rubber bits
- Sidepulls and bit converters
- Double-twisted wire and gag bits
- [Kimberwicke Bits](#)

Other tack and equipment

Required

- Whips or crops may be no longer than 47.2 inches (120 cm) including lash

Optional

- Breastplates or breast collars

Not allowed

- martingales
- bit guards
- accessories (bearing, side, running, balancing reins, etc.)
- any type of boots or bandages
- any form of blinkers or nose covers
- seat covers

DR105 – Grooming

[Equines may be groomed/trimmed according to breed type or left unclipped as a personal choice with no penalties.](#)

4-H EQUINE PROGRAM RULEBOOK

It is typical to have the mane and forelock braided for a neater, more complete appearance. Tails should be left natural or maybe banded.

DR106 – Class Procedure

Dressage tests are ridden individually and generally with scheduled ride times. Riders should plan their warm-up so that they are prepared to enter the arena at their scheduled ride time. Rides may be delayed but may not be called earlier than scheduled without approval of the rider. Tests may be read but must be limited to reading each movement one time only, as it is written.

Test requirements are the same for juniors, intermediates, and seniors. Tests are to be ridden and judged according to USEF Dressage rules except where noted in this rule book. Tests to be used are the current approved USEF tests, which are usually updated by USEF every 4 to 5 years. Exhibitors should make sure they are using the most current test each year.

The number of tests ridden and scored is at show management discretion, as counties determine specific qualifying criteria for State 4-H Fair.

DR107 – Tests

See the [Forms and Documents page of the USDF website](#) for downloadable tests.



4-H EQUINE PROGRAM RULEBOOK

DRE – Dressage (English) Seat Equitation

DRE101 - Purpose

The purpose is to promote and reward correct seat, position and use of aids. Dressage Seat Equitation is an opportunity for Dressage riders to be evaluated on their overall correctness of position, relaxation and suppleness of the rider, lightness, and correct application of the aids.

DRE102 - Scoring

1. [Member and appointments](#)

Clothing, equipment, courtesy, poise15%

2. [Seat and hands](#)

Seat, posture, head, legs, hands, balance, distribution of weight, aids.....35%

3. [Performance](#)

Ability to maintain tempo and rhythm with the horse, along with overall performance.....50%

100 points total

Judging is based on the position, seat and proper use and effect of the aids. Refer to Training and First Level Dressage Tests for more information. Dressage tests are judged as described on the test document found at [DR107 - Tests](#)

All movements should be obtained without apparent effort of the rider. The rider should be well balanced with loins and hips supple, and thighs and legs steady and well stretched downward. The upper part of the body should be easy, free, and erect with the hands low and close together without touching each other or the horse. The elbows and arms are close to the body, allowing the rider to follow the movements of the horse smoothly and freely and to apply the aids imperceptibly.

Gaited Horses – Refer to [GR106.3](#)

Use of voice will be penalized.

DRE103 - Attire

See [DR103 - Dressage Attire](#)

DRE104 - Equipment

See [DR104 - Dressage Equipment](#)

DRE105 – Grooming

See [DR105 - Dressage Grooming](#)

4-H EQUINE PROGRAM RULEBOOK

DRE106 – Class Procedure

The movements or gaits shall be performed by the exhibitors simultaneously, same as with other equitation classes. The movements or gaits that must be performed are medium walk, working trot (sitting and rising), and working canter both ways of the ring. Transitions in gait are from medium walk to working trot to canter.

In judging the position, seat and use of aids, judges may include the following movements and exercises as required at Training and First Level:

May be ridden as a group:

- a. Free walk
- b. Transitions from one gait to the next in both directions
- c. Transitions from walk to halt and halt to walk
- d. Change of direction – may be a half circle at the walk or trot, on the diagonal, down the centerline or across the arena.

Additional tests the judge may ask however are to be ridden in small groups or individually:

- a. Transitions
- b. Leg yield
- c. Changes of lead through trot
- d. Serpentine at the trot
- e. Shallow loop serpentine in canter, maintaining lead
- f. Lengthened trot and/or lengthened canter

4-H EQUINE PROGRAM RULEBOOK

WD - Western Dressage

WD101 – Purpose

The development of the western rider and horse to improve themselves as individuals and partners through the use and discipline of dressage. Western Dressage will help the rider improve the horse's cadence, balance, and carriage and help them utilize the dressage fundamentals to create suppleness, flexibility, and increase the horse's ability to work from his haunches. 4-H Western Dressage rules are closely aligned with USEF Western Dressage Association of American rules.

WD102 – Scoring

In a Western Dressage test, rider and horse perform certain movements specific to the level at which they are competing. Each of these movements is scored out of 10 by the judge, who is seated at "C" just outside the arena. Some particularly difficult movements received double marks, and the rider's skill is also marked. The total marks are then converted into a percentage score for the combination – the higher the better.

Western Dressage Tests are designed with progressive elements to demonstrate the developing skills of horse and rider.

A Horse/Rider combination shall enter no more than two consecutive levels.

Gaited Horses – Refer to [GR106.3](#)

WD103 - Attire

See [WEQ103 - Western Equitation Attire](#)

Optional

- Bolo Tie, necktie, kerchief or pin
- Chaps, Shotgun Chaps, Chinks, armitas or split riding skirt
- Half chaps (must have western style decorations)

WD104 - Equipment

Bridles

- Any Western style headstall
- A Hackamore (Bosal). Bosals may be wrapped with smooth electrical tape to prevent rubbing.
- The Western Two Rein bridle is permitted. This is a bridle and bit, snaffle or curb ridden over a full or pencil bosal or bosalita. The following are acceptable ways to hold the reins when using a Two Rein bridle:
 - The two Rein with Snaffle Bit: The two rein with snaffle consists of a snaffle bit and a pencil or full bosal or bosalita. The rider will hold a bosal rein (mecate) and a snaffle rein in each hand.

[Return to Table of Contents](#)

4-H EQUINE PROGRAM RULEBOOK

- The two Rein with Curb Bit: The rider has the following choices:
 - Split Reins: When using a curb bit with Split reins and a pencil bosal or bosalita, the rider can ride with all reins in one hand but can only have one finger between the reins or the rider can ride with a bit rein and a bosal rein in the left hand and a bit rein and bosal rein in the right hand.
 - Romal Reins: When using a curb bit with Romal Reins and a pencil bosal or bosalita the rider has two options:
 - A romal must be held with one hand with the romal coming up from the bottom and out of the top of the hand. The bosal rein can then be held in the opposite hand.
 - A romal and bosal may be ridden in one hand, the reins coming up from the bottom of the hand and out of the top. No fingers can be between the reins.

Note: When using a curb bit as part of the Western two rein bridle, only a pencil bosal or bosalita can be used, not a full bosal.

The end of the mecate called the tail, can be wrapped around the saddle horn or slipped under the rider's belt.

- Snaffle Bit: A snaffle bit may be used on a horse of any age being ridden at any level. A snaffle offers no leverage or curb action.
- Bitless Bridles:
 - A bitless bridle is permitted on a horse of any age at any level.
 - All bitless bridles must be of Western style made of flat leather or leather-like materials.
 - Cross under bitless bridle - a simple and subtle two loop system, one over the poll and one over the nose that embraces the whole of the head. No other variations are permissible
 - Bitless bridles with sidepulls are prohibited.

Reins:

- When the rider uses a snaffle bit, the following reins may be used: loop/connected reins, split reins, buckled reins, mecate reins, or Romal reins without a popper; two hands must be used with any of these combinations. Horsehair, rope reins and mecate reins are allowed for bosals and snaffles. The mecate tail can be tied to the saddle horn, held by the rider, or looped in the rider's belt.
- When the rider uses a curb, the following reins may be used: Romal reins, Split reins, loop/connected reins, buckled reins or Romal reins without a popper. When using a curb with Romal reins with a popper, only one hand is allowed; when using other rein choices, one or two hands are allowed.

[Return to Table of Contents](#)

4-H EQUINE PROGRAM RULEBOOK

Saddle: A standard Western stock saddle with swells, a seat, cantle, skirt, fenders, and Western stirrups is required.

Prohibited

- Slip or gag bits, half cheeks, snaffle bits with hooks and slots, donut or flat polo mouthpieces and kimberwicks.
- Roping bits with reins attached to a single ring at the center of a cross bar.
- Any rein design or other devices which increase the effective length and thereby the leverage of the shank of a standard western bit.
- Round, rolled, braided or rawhide curb straps

Optional

- Whip with a maximum length of 47.2" (120cm) including lash
- A Western cavesson (braided or plain), or pencil bosal with space for two fingers placed between the cavesson and the jowl of the horse is allowed. The inside of the noseband must be smooth and free of any metal except for a buckle.

WD105 – Grooming

Horses may be groomed/trimmed according to breed type. or left unclipped as a personal choice with no penalties. It is typical to have the mane and forelock and tails natural, however, manes may be banded.

WD106 – Class Procedure

Dressage tests are ridden individually and generally with scheduled ride times. Riders should plan their warm-up so that they are prepared to enter the arena at their scheduled ride time. Rides may be delayed but may not be called earlier than scheduled without approval of the rider. Tests may be read but must be limited to reading each movement one time only, as it is written.

WD107 – Tests

See the [Tests page](#) of the [WDAA Website](#) for downloadable tests.



[Return to Table of Contents](#)

4-H EQUINE PROGRAM RULEBOOK

WDE – Western Dressage Equitation

WDE101 – Purpose

The purpose is to provide an opportunity for the rider to demonstrate their ability to perform requested maneuvers smoothly and precisely with confidence and poise working in harmony with their mount all while maintaining correct body position.

WDE102 – Scoring

1. [Member and appointments](#)
Clothing, equipment, courtesy, poise15%
 2. [Seat and hands](#)
Rider Position-Seat, posture, head, legs, hands, balance, distribution of weight, aids.....35%
 3. [Performance](#)
Harmony, effective use of aid and accuracy along with ability to maintain tempo
and rhythm with the horse and overall performance.....50%
- 100 points total

Gaited horses are ridden at the intermediate gait instead of the jog. Gaited Horses – Refer to [GR106.3](#)

WDE103 - Attire

Refer to [WD103 - Western Dressage Attire](#)

WDE104 - Equipment

Refer to [WD104 - Western Dressage Equipment](#)

WDE105 – Grooming

Refer to [WD105 - Western Dressage Grooming](#)

WDE106 – Class Procedure

Western Dressage Seat Equitation is a rail performance class to be shown at the walk, working jog, and working lope, both directions. Horses should back easily and stand quietly in the lineup. Judges may ask for any additional gaits or movements included in Basic and Level 1 Tests. Depending on the movement, the class may be divided, or movements performed individually.

4-H EQUINE PROGRAM RULEBOOK

DV – Driving

DV101 – Purpose

Driving classes allow a youth to exhibit their skills in guiding their driving equine through various class requirements. Any size equine is allowed. Driving is especially useful for small equines or ponies that are too small for riding or whose rider has outgrown them.

Safety is a high priority. Any entry the judge feels is unsafe may be dismissed whether due to turnout or behavior of the animal. Management should permit only the number of entries that can be shown safely at one time for the size of the ring. Age divisions may be combined if classes are small, [however, they would be placed separately.](#)

DV102 – Scoring

See each class for scoring

Appointments

Equine

Exhibitors may drive a single horse, pony, miniature, mule, or donkey. Classes may be divided into 4-H member age groups, by the size of the animal, or both. The animal must not be asked to pull too much weight (see 4-H Driving Manual [PNW 229] for specifics). When determining animal height, allow an additional ½ inch if shod.

Natural gaits are desirable. Chains are prohibited. It is permissible to stretch or park your horse if breed and turnout are appropriate.

Gaited Horses – Refer to [GR106.3](#)

DV103 - Attire

Required for Drivers

- Long-sleeved shirt that is neat, clean, and well fitted
- Jeans, slacks, or an ankle-length skirt; or a conservative dress with long sleeves
- Riding boots or sturdy, hard soled shoes
- Gloves (may be black or brown, but brown is traditional)
- Driving whip (should be long enough to reach the equine's shoulder)
- ASTM/SEI helmet

Optional

- English or Western riding attire
- Vest or jacket
- Driving apron

Not allowed

- Evening wear
- Spurs

[Return to Table of Contents](#)

4-H EQUINE PROGRAM RULEBOOK

Required for Headers—Hard-soled shoes or boots, a long-sleeved shirt, and jeans or slacks. Spurs are not allowed. [It is recommended that Headers be a 4-H member, parent of the driver, or enrolled volunteer.](#)

DV104 - Equipment

Vehicle

Required

- An appropriate two- or four-wheeled vehicle
- A footrest or basket (a minimum of 10 inches front to back) securely fastened to the vehicle. The basket must be constructed so the driver's feet cannot get stuck.
- Shafts should be equipped with a single tree or trace hooks.
- The vehicle should be in safe, usable condition and should fit the animal to which it is attached.

Not allowed

- Racing sulkies or roadster bikes

Harness

A leather or synthetic, pleasure-type harness is acceptable. For safety reasons, a nylon harness is not recommended. The harness must be in safe, useable condition and must fit the animal wearing it. The reins must be either buckled or stitched together.

Required

- Crupper
- Thimbles or breeching are NOT required except when hitched to a four-wheeled vehicle (e.g., wagon or buggy).
- Wrap straps or overgirth
- Blinkers (or blinders)
- Cavesson noseband
- Snaffle or driving curb bit

Optional equipment

- Overcheck or sidecheck
- Running martingale
- Kicking strap (recommended)
- Support boots, quarter boots, splint/brushing boots

Not allowed

- Twisted wire or gag bits

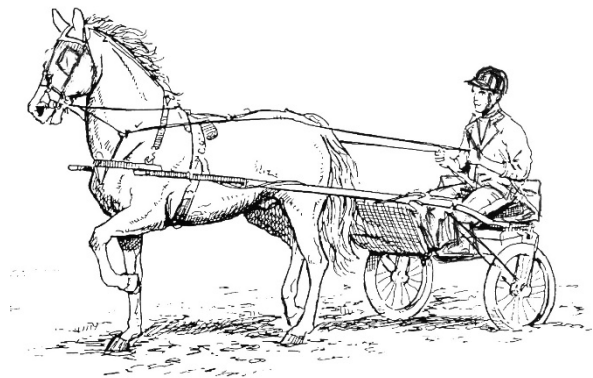

Whip

Required

- Driving or buggy whip. It should be carried in the right hand.

Not allowed

- Longeing-type whip
- Fetlock Chains are prohibited.

4-H EQUINE PROGRAM RULEBOOK

DR105 –Grooming

Equines may be trimmed/groomed according to breed/type or left unclipped as a personal choice with no penalties.

DR106 – Class Procedures and Safety

[See each Class Description](#)

Exhibitors may drive a single horse, pony, miniature, mule, or donkey. Classes may be divided into 4-H member age groups, by the size of the animal, or both. The animal must not be asked to pull too much weight (see 4-H Driving Manual [PNW 229] for specifics). When determining animal height, allow an additional ½ inch if shod.

Natural gaits are desirable. It is permissible to stretch or park your horse if breed and turnout are appropriate.

Headers

One properly dressed intermediate, senior, or adult header is required for each driver in the lineup. The header should enter the arena once all the entries have lined up and permission to enter has been granted. The header should not touch the animal except in case of a potential emergency.

Exhibitors Reminders

- Do not lead your horse with no one in the cart.
- Extreme speed will be penalized.
- Pass other vehicles on the inside unless horses of different sizes are being shown in the same class. In that case smaller equines should stay to the inside allowing the larger equine to have the rail. Be sure to watch the traffic. Avoid cutting back to the rail immediately in front of another driver.
- In case of a runaway, all other drivers are to move off the rail to the center of the arena and stay in their vehicles. Most frightened horses will run the rail looking for a way out.

4-H EQUINE PROGRAM RULEBOOK

DVR - Driving Reinsmanship

DVR101 - Purpose

Reinsmanship is the art of communicating with the carriage driving horse through the reins, whip, and voice. Of course, it goes much deeper than that. The driver's timing in the use of those aids along with her or his own body position have a significant impact on how effective those communications are.

DVR102 - Scoring

1. Appointments

Proper harnessing and hitching; condition of equine, harness, and vehicle25%

2. Driver

Handling of reins and whip, control, posture, and overall appearance.....35%

3. Performance

On rail and in pattern40%

100 points total

Gaited Horses – Refer to [GR106.3](#)

Basis for judging

Reinsmanship is judged as an equitation class on hands, proper harnessing and hitching, and correct driving techniques. The driver should be able to change gaits quickly, smoothly, and unobtrusively while always maintaining contact and using correct driving techniques. This class is designed to test the driver's knowledge and ability. A pattern is required. Extreme speed or extreme high action due to a horse's length of foot, pads, or weighted shoes will be penalized.

DVR103 - Attire

Refer to [DV103 - Driving Attire above](#)

DVR104 - Equipment

Refer to [DV104 - Driving Equipment above](#)

DVR105 - Grooming

Refer to [DV105 - Driving Grooming above](#)

DVR106 - Class procedure

Drivers enter and line up a safe distance apart, with headers, for inspection by the judge. Drivers proceed at the direction of the judge on the rail and work both directions of the ring at a flat-footed walk, slow trot, working trot, and strong trot/extended trot. The reverse will be executed on a diagonal at a walk or working trot from a designated corner at the direction of the judge or ring steward. Drivers line up according to instructions by the judge or ring steward. Horses must stand quietly in line.

4-H EQUINE PROGRAM RULEBOOK

DVR107 – Tests

Pattern must be age/level appropriate for both the equine and driver.

- Back four steps and close the back.
- Drive a circle of specified size.
- Drive a figure 8.
- Drive at a strong trot.
- Negotiate a simple obstacle (i.e., drive between two obstacles at a working trot or halt between two given markers).
- Pivot (turn) with one wheel in place, left or right, 90, 180, or 360 degrees, at the judge's direction.
- Back between two markers.
- Drive at a lengthened flat-footed walk.
- Answer a 4-H driving question posed by the judge.

Patterns may include other elements.

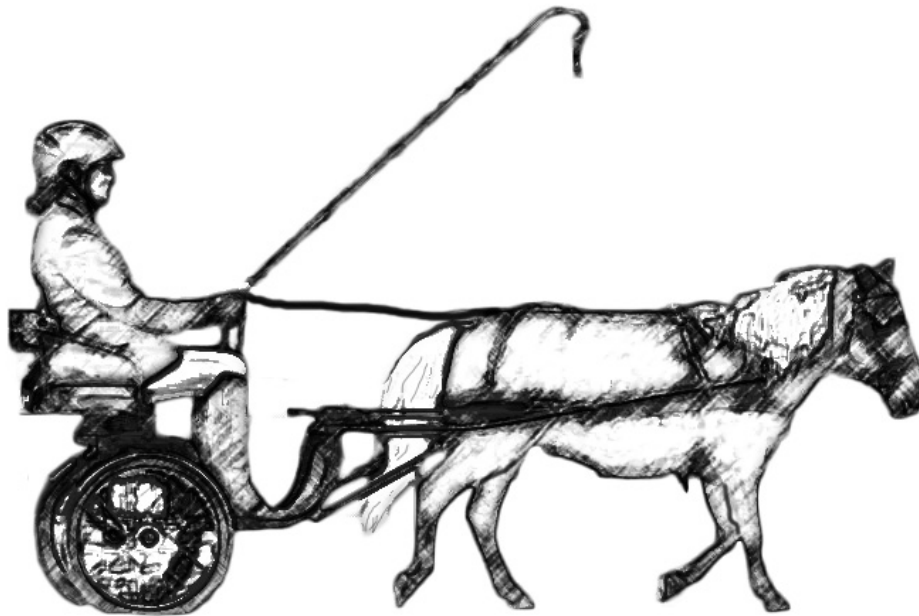

4-H EQUINE PROGRAM RULEBOOK

DVPr - Precision Driving

DVPr101 - Purpose

The Precision Driving class tests the skill of the driver, the obedience and handiness of the animal, and the accuracy with which the course is driven.

DVPr102 – Scoring

- A perfect score of 100 points is based on a maximum of 80 points for a fault-free* performance and 20 points for reinsmanship and overall smoothness of the performance.
- Faults are deducted in 5-point increments from the possible 80, while single-point deductions are made from the 20 points.
- Example: A driver incurs three faults and receives a score of 13 for reinsmanship/performance. The three faults (at 5 points each) total 15 points; these are deducted from 80, resulting in 65 points. Those 65 points along with the 13 reinsmanship/performance points yield a final score of 78.
- 100 points total

Gaited Horses – Refer to [GR106.3](#)

DVPr103 - Attire

Refer to [DV103 - Driving Attire above](#)

DVPr104 - Equipment

Refer to [DV104 - Driving Equipment above](#)

DVPr105 - Grooming

Refer to [DV105 - Driving Grooming above](#)

DVPr106 - Class procedure

All drivers must submit to an inspection by the judge before starting the course. Competitors will be required to drive over a course consisting of 6 to 8 obstacles. Markers may be used to indicate obstacles (traffic cones with tennis balls on top work well). A course may be set up using only cones with tennis balls if other obstacles are not available. The course will be irregular, necessitating changes of direction.

Measurements

- Markers indicating obstacles will be at least 12 inches wider than the track width of each vehicle (measured from the outside edge of one wheel to the outside edge of the other wheel).
- Markers must be at least 12 inches high.
- Lanes may be defined by rails at least 3 inches in diameter.
- If the course calls for a walk between poles (the vehicle's wheel goes between the poles), the poles must be 6 to 8 inches apart.

[Return to Table of Contents](#)

4-H EQUINE PROGRAM RULEBOOK

- If the course calls for a trot between poles (the vehicle's wheel goes between the poles), the poles must be 10 to 12 inches apart.
- Serpentine cones should be at least 27 feet apart with cones set on a straight line.
- Figure 8s should have a minimum of 30 feet between two marker cones.
- Squares should have at least 10-foot sides.
- L-shaped obstacles should be at least 10 feet wide.
- U-shaped obstacles should be at least 10 feet wide.
- Bridges should be a minimum of 8 feet wide and 12 feet long with cones at all four corners (minimum 4-foot ramp up, 4-foot flat surface, and 4-foot ramp down).

* Faults: First and second refusal, displacing any marker, hoof or wheel outside marker, and breaking gait will each incur a 5-point deduction.

Elimination: Three cumulative refusals, receiving outside assistance of any sort, showing an obstacle to the horse, or taking an obstacle out of order (off course)

4-H EQUINE PROGRAM RULEBOOK

Sample Precision Driving Courses (Suggestions Only)

Sample course #1:

1. Enter at a trot.
2. Trot through a 10-foot square (4 cones).
3. Trot a serpentine of 5 cones (25 feet apart).
4. Walk with right wheel(s) between poles (6 to 8 inches apart).
5. Trot a figure 8 (at least 30 feet around A then B).
6. Walk with left wheel(s) between poles.
7. Walk a serpentine.
8. Walk into square, stop with front wheels between front cones, back up 4 steps, and return to forward position.
9. Stand quietly until dismissed by the judge or ringmaster.

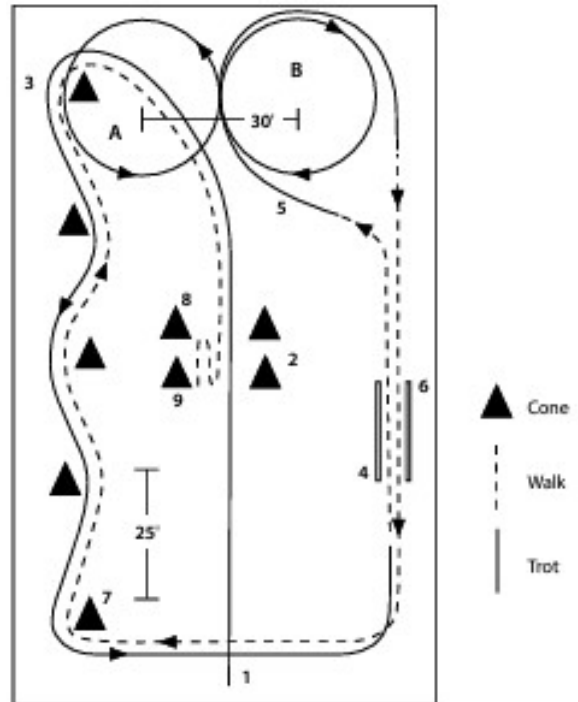

Sample course #2:

1. Enter at a trot.
2. Trot through two pairs of cones (CDEF, 10-foot square).
3. Trot a figure 8 (B, then A).
4. Trot a serpentine of 5 cones (25 feet apart).
5. Walk with right wheel(s) between poles (6 to 8 inches apart).
6. Walk to the top of the cone square. Halt with cone C on your left, facing the serpentine. Pivot 90 degrees to the right. Back into the square, between cones C and D, until the cart is between E and F. Halt and stand 10 seconds. Trot back forward through the box.
7. Trot with left wheel(s) between poles and exit.

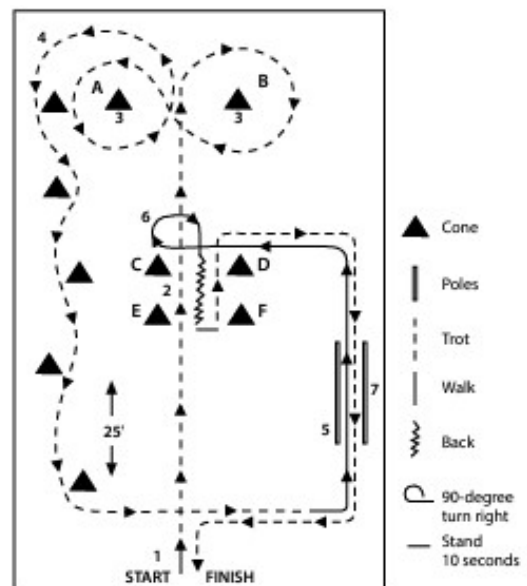

4-H EQUINE PROGRAM RULEBOOK

DVPL - Pleasure Driving

DVPL101 - Purpose

Pleasure Driving is a test of the suitability of the driving horse with manners, quality of gaits and way of going emphasized.

DVPL102 - Scoring

1. Appointments
Fit, condition, and appropriateness of harness and vehicle.....10%
 2. Driver
Handling of reins and whip, control, posture, and neatness of attire.....30%
 3. Performance
Manners, performance, condition, style, and way of going.....60%
- 100 points total

Gaited Horses – Refer to [GR106.3](#)

Basis for judging

The Pleasure Driving horse should have the same general qualities as the Pleasure Saddle horse. Special emphasis is placed on the flat-footed walk and the pleasurableness of the ride for the driver. The horse should be in balance with a head and carriage typical of its breed or type, be light-mouthed, and have a free way of moving. At all gaits, it must work in form (i.e., head held quietly, mouth closed, and legs working beneath itself). The traces should be steady at all times, demonstrating consistency of forward motion and that the horse is pulling from the traces, not from the mouth or saddle. Erratic movements are highly undesirable. Hesitation or breaking stride will be penalized. Extreme speed or extreme high action due to the horse's length of foot, pads, or weighted shoes will be penalized.

DVPL103 - Attire

Refer to [DV103 - Driving Attire above](#)

DVPL104 - Equipment

Refer to [DV104 - Driving Equipment above](#)

DVPL105 - Grooming

Refer to [DV105 - Driving Grooming above](#)

DVPL106 - Class procedure

Drivers enter and line up a safe distance apart, with headers, for inspection by the judge. Drivers proceed at the direction of the judge on the rail and work both directions of the ring at a flat-footed walk, slow trot/jog, working trot/jog, and strong trot. The reverse will be executed on the diagonal at a walk or working trot from a designated corner at the direction of the judge or ring steward. Drivers line up according to instructions by the judge or ring steward. Horses must stand quietly in line.

[Return to Table of Contents](#)

4-H EQUINE PROGRAM RULEBOOK

DD - Driven Dressage

DD101 - Purpose

The purpose of driven dressage is the harmonious development of the physique and ability of the horse through progressive training. The aim of the levels in driven dressage is to encourage the correct training and development of the horse while offering achievable goals for the driver.

DD102 - Scoring

Danish points are suggested as follows:

- 55 and above – Blue, Reserve Grand, Grand,
- 45-55 – Red,
- 45 and below – White.

Grand and Reserve Grand will be awarded to the highest and second highest score by levels, provided the minimum scores indicated above are met.

DD103 - Attire

Refer to [DV103 - Driving Attire above](#)

DD104 - Equipment

Refer to [DV104 - Driving Equipment above](#)

DD105 - Grooming

Refer to [DV105 - Driving Grooming above](#)

DD106 - Class Procedure

Dressage tests are driven individually. The execution of the tests is not timed. Times shown on the test sheets are for scheduling information only.

Tests may be read but must be limited to reading each movement one time only, as it is written.

Test requirements are the same for juniors, intermediates, and seniors.

Warm-Up: Competitors shall be allowed to drive the outer perimeter of the arena before entering if possible. If this is not possible, the competitor may be allowed one minute to warm up in the arena. At the end of one minute a bell will be rung and the competitor will proceed to enter at A and begin the course.

DD107 - Tests

The American Driving Society Arena Trial (AT) tests will be used in all 4-H competitions. These tests are designed to be driven in an arena smaller than 40m x 80m.

Tests to be used are the current approved tests, which are updated periodically. Exhibitors should make sure they are using the most current test each year.

[Return to Table of Contents](#)

4-H EQUINE PROGRAM RULEBOOK

SM – Small Equine In-Hand

SM101 - Purpose

The small equine in-hand division was developed to provide a place for horse project members whose equine may be too small to ride. Throughout this [section](#), when the word “equine” is used it specifically refers to small equine.

Unless otherwise specified, exhibitors may wear standard western or English attire as described in this Rule Book.

Eligibility for Showing

Height

Small Equine In-Hand classes are open to any equine (miniature horse, pony, donkey or mule) that is 48” or less when measured at the highest point of the withers.

Please note that this may be a different way of measuring than what miniature horse owners are used to. If you have used the height at the last hair of the mane before, you will need to remeasure your equine at the highest point of the withers.

Height categories are used for setting jump and obstacle dimensions. Based on their measurement, equines shall be assigned to the appropriate height category as described below:

- Category A: Under 34” (and in jumping classes, all donkeys)
- Category B: 34” up to, but not including, 38”
- Category C: 38” and over, through 48”

Age

The show age of equines less than 36 months of age is determined by their age on the day of the show.

- Equine must be 12 months or older to compete in obstacle classes.
- Equine must be 36 months or older to compete in jumping classes.

SM102 - Scoring

Refer to each Small Equine In -Hand class for scoring information.

SM103 - Attire

Required

- Exhibitor may wear either English or Western attire.
- Riding boots, paddock boots or sturdy leather shoes.

Optional

- Helmet

Not Allowed

- Spurs
- Chaps

4-H EQUINE PROGRAM RULEBOOK

- [Whips/crops](#)

SM104 - Equipment

- The equine must be shown in a working halter with a throatlatch. The halter may be made of leather, synthetic leather, rope, or webbing.
- The lead may be flat or rounded. The exhibitor's end of the lead must be without a loop. Length must be appropriate to the size of the equine, but not less than six feet or longer than ten feet.
- A chain under the chin may be used.

Not Allowed

- Chains over the nose
- Arabian-style halters (allowed only in Showmanship)
- Any tack on the body (except for the halter). For example, surcingles or similar objects to keep the head under control.

SM105 - Grooming

[Equines may be trimmed/groomed according to breed/type or left unclipped as a personal choice with no penalties.](#)

4-H EQUINE PROGRAM RULEBOOK

SMD – Small Equine Dressage In-Hand

SMD101 - Purpose

Dressage In-Hand is comparable to ridden Dressage in its execution and scoring. Emphasis should be placed on suppleness, basic gaits, figures, impulsion, and transitions in the performance of the horse, as produced by the handler.

SMD102 - Scoring

1. Execution.....	50%
2. Collective Remarks (gaits, impulsion, submission, exhibitor, presentation).....	50%
	100 points total

Overview

Each movement is scored (0 to 5 points) to establish whether it was insufficient (2 or below) or sufficient (3 or above).

Arena Layout

The dressage arena must be rectangular in shape, with the short sides half as long as the long sides. The arena should not be as large as a ridden dressage arena, but it must be large enough for the Category C equines to complete their maneuvers smoothly. 10x20 meters is a good starting point. The basic dressage letters will be posted (A, B, C, E, F, H, K, M)

Execution of the Test

- Voice signals and/or clicking the tongue are prohibited.
- Tests may be read during the competition, but no part of a test may be read more than once.
- Lateness or errors in reading the pattern will not relieve the exhibitor from error penalties.
- Coaching by anyone is prohibited and will result in the elimination of the exhibitor.

SMD103 - Attire

Refer to [SM103 - Small Equine Attire above](#)

SMD104 - Equipment

Refer to [SM104 - Small Equine Equipment above](#)

SMD105 - Grooming

Refer to [SM105 - Small Equine Grooming above](#)

SMD106 Class Procedure

Exhibitors enter individually and execute the test as provided leading their equines in the proper manner on the left of the equine.

4-H EQUINE PROGRAM RULEBOOK

SMD107 - Tests

Below is a sample of a Dressage Test Pattern. Show management or a judge may design an appropriate test.

Small Equine In-Hand - Sample Dressage Test Pattern

Dressage Test Pattern:	
<div style="border: 1px solid black; padding: 5px;"> <div style="display: flex; justify-content: space-between;"> 1 A </div> <div style="margin-top: 10px;"> <ul style="list-style-type: none"> ● A - Enter working walk ● X - Halt, salute </div> </div>	<div style="border: 1px solid black; padding: 5px;"> <div style="display: flex; justify-content: space-between;"> 6 A </div> <div style="margin-top: 10px;"> <ul style="list-style-type: none"> ● C to B -Working trot </div> </div>
<div style="border: 1px solid black; padding: 5px;"> <div style="display: flex; justify-content: space-between;"> 2 A </div> <div style="margin-top: 10px;"> <ul style="list-style-type: none"> ● X - Proceed working trot ● C - Track left ● C to E - Working trot </div> </div>	<div style="border: 1px solid black; padding: 5px;"> <div style="display: flex; justify-content: space-between;"> 7 A </div> <div style="margin-top: 10px;"> <ul style="list-style-type: none"> ● B - Circle right at the trot, width of arena </div> </div>
<div style="border: 1px solid black; padding: 5px;"> <div style="display: flex; justify-content: space-between;"> 3 A </div> <div style="margin-top: 10px;"> <ul style="list-style-type: none"> ● E - Halt, move to the off side ● E - Circle left at the trot, width of arena </div> </div>	<div style="border: 1px solid black; padding: 5px;"> <div style="display: flex; justify-content: space-between;"> 8 A </div> <div style="margin-top: 10px;"> <ul style="list-style-type: none"> ● B to F - Transition to walk ● FAX -Walk down centerline </div> </div>
<div style="border: 1px solid black; padding: 5px;"> <div style="display: flex; justify-content: space-between;"> 4 A </div> <div style="margin-top: 10px;"> <ul style="list-style-type: none"> ● E to A - Working trot ● A - Halt, move to near side ● AFB -Working walk </div> </div>	<div style="border: 1px solid black; padding: 5px;"> <div style="display: flex; justify-content: space-between;"> 9 A </div> <div style="margin-top: 10px;"> <ul style="list-style-type: none"> ● X - Halt 3-5 seconds ● X -Back 2-4 steps </div> </div>
<div style="border: 1px solid black; padding: 5px;"> <div style="display: flex; justify-content: space-between;"> 5 A </div> <div style="margin-top: 10px;"> <ul style="list-style-type: none"> ● B to H - Free walk on a long lead across diagonal ● H to C - Working walk </div> </div>	<div style="border: 1px solid black; padding: 5px;"> <div style="display: flex; justify-content: space-between;"> 10 A </div> <div style="margin-top: 10px;"> <ul style="list-style-type: none"> ● X to G - Proceed at working walk ● G - Halt, salute ● </div> </div>

4-H EQUINE PROGRAM RULEBOOK

Small Equine In-Hand Scoresheet – Sample Dressage In-Hand (Side 2)

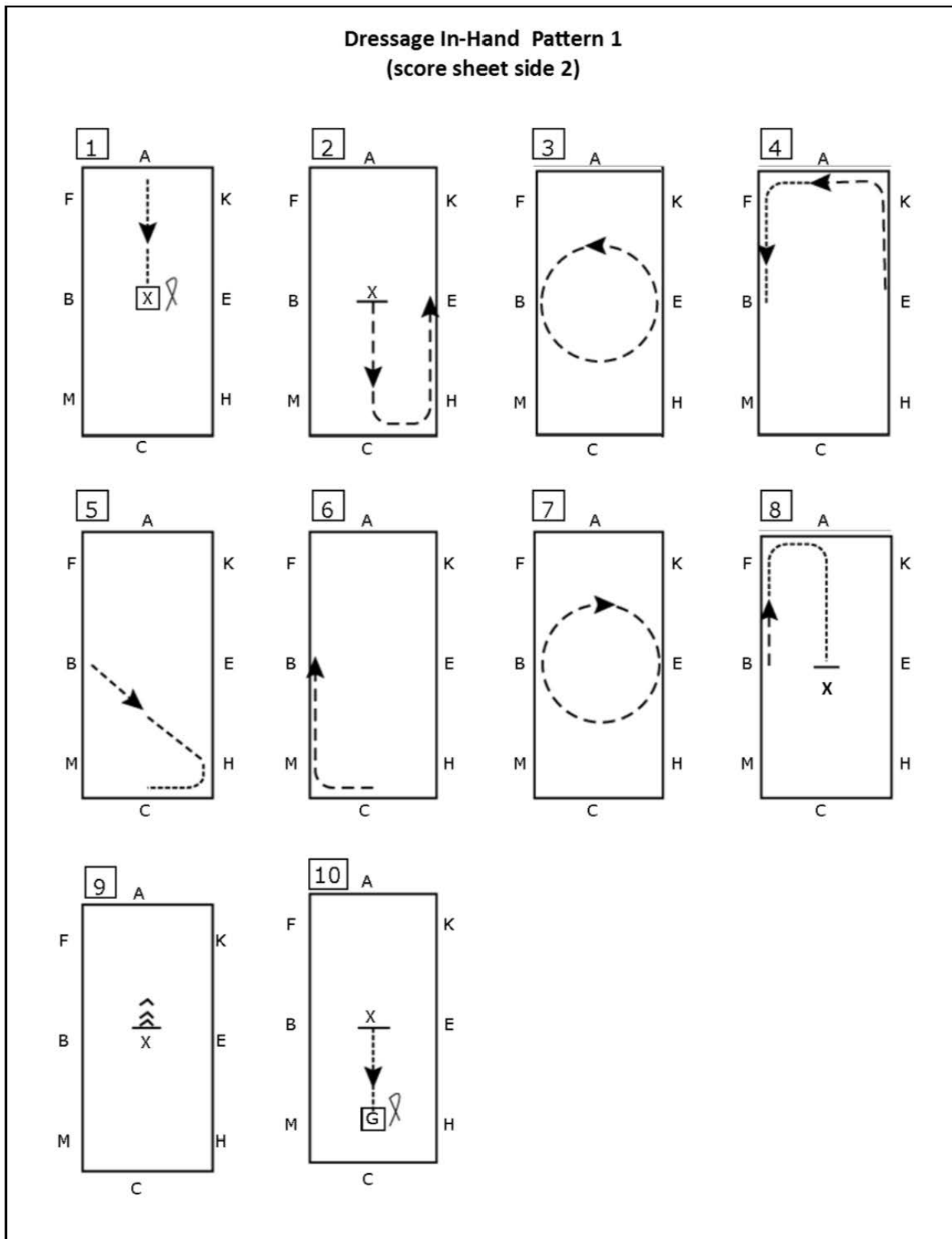

4-H EQUINE PROGRAM RULEBOOK

SMO – Small Equine Obstacles In-Hand

SMO101 – Purpose

Obstacles In-Hand is a disciplined event designed to test the working relationship between equine and exhibitor.

SMO102 - Scoring

1. Execution80%
2. Overall Performance20%

Description

The course will consist of obstacles of various types. The class is judged on the exhibitor's ability to guide the equine through the course with control and precision. The equine's performance and way of going with an emphasis on manners throughout the course is also considered along with the responsiveness and willingness of the equine.

Unlike In-Hand Trail, which is based on obstacles found along the trail, the obstacles in Obstacles In-Hand are specifically chosen to test the exhibitor's ability to control and maneuver the equine.

Course Layout

The course will consist of six obstacles. A start and finish line must be established at a safe distance from the first and last obstacle and indicated by two markers at least 4 feet apart. The exhibitor must go between these markers in the proper direction to officially start and end the pattern otherwise the exhibitor is considered off course.

At least three different categories of obstacles must be used. (See obstacle description charts.) Course designs must ensure all safety precautions are taken and the judge has the right to alter any course that they feel may be unsafe before the first equine is on course. If the course must be altered after the first equine has completed the course, that equine will be allowed to rerun the course.

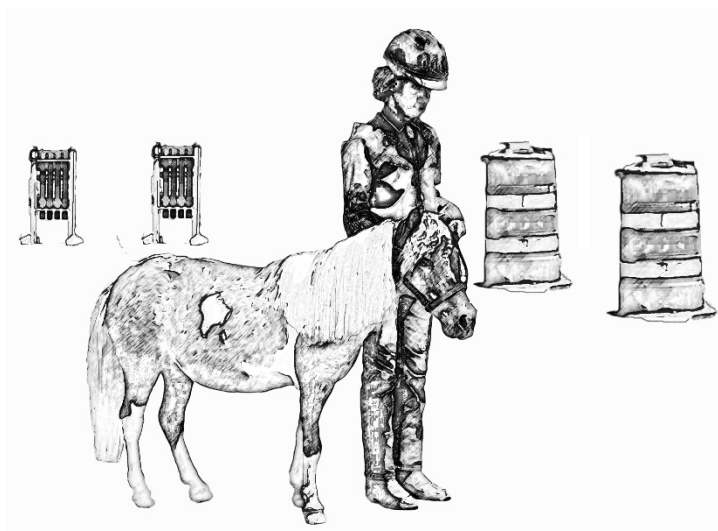

4-H EQUINE PROGRAM RULEBOOK

SMO103 - Attire

Refer to [SM103 - Small Equine Attire](#)

SMO104 - Equipment

Refer to [SM104 - Small Equine Equipment](#)

SMO105 - Grooming

Refer to [SM105 - Small Equine Grooming](#)

SMO106 - Class Procedures

Exhibitors compete one at a time over a set pattern of obstacles. The dimensions of the obstacles will be adjusted according to the height category of the equine. The height category of the equine will be used to determine the order in which the exhibitors enter the ring. However, judging of all obstacle classes is done by the age group of the exhibitor. The judge must be available to perform a walk through the course with exhibitors prior to commencement of the class. Only exhibitors are permitted on the course – no equines until the commencement of the class.

Cueing

Exhibitors are permitted to cue their equine by the use of voice commands and hand signals. Most other forms of cueing are penalized. Penalized cueing includes but is not limited to:

- hitting the equine with lead rope or other object
- physically pushing the equine in any direction
- deliberate body or hand contact with the equine
- any obvious intimidation of the equine
- holding the equine by the halter rather than the lead
- stepping on or in an obstacle with the equine unless the course layout requires it or by direction of the judge.
- backing equine by aggressively shaking the lead rope
- baiting with food or other objects

Course Penalties:

Each of the following occurrences will lead to an automatic 30-point deduction:

- Negotiating obstacles in the wrong direction (off course)
- Taking obstacles in the wrong order (off course)
- Falling of the equine or exhibitor

General Penalties

- Failure to complete an obstacle is not a disqualification but should be penalized accordingly.
- An exhibitor may attempt any obstacle up to three (3) times but then they must move on to the next obstacle.

4-H EQUINE PROGRAM RULEBOOK

- Maximum time is 60 seconds per obstacle. After the time is used, the exhibitor will be directed to move on.
- Exhibitors shall be penalized for any unnecessary delay in approaching an obstacle.
- Refusals are not a disqualification but should be faulted accordingly.

Disqualifications

- Equine running free of the exhibitor.
- Willful abuse of the equine by the exhibitor
- Leaving arena without permission of the judge or steward

Obstacles

The following obstacles are prohibited:

- Tire and stair obstacles
- Logs or poles elevated in such a manner that allows them to roll.
- Rocking or moving bridges.

Pole Requirements

- Poles on the ground should be 1½" to 4" in diameter and at least 5' long, unless otherwise specified.
- Elevated poles should be 1½" to 2" in diameter and 5' to 6' long.
- Poles can be made of wood or schedule 40 PVC pipe, depending on the location & use of the pole.

Cone Requirements

- Cones should be at least 10" tall.
- Cones may be of any color or combination of colors.

4-H EQUINE PROGRAM RULEBOOK

“Over” Category Obstacles

Obstacle	Information	Category Adjustments	Penalties
Bridge	Equine must walk over a raised bridge (can have incline/decline, step up/down, or be flat) Bridges must be sturdy & safe without sides. Rocking/moving bridges prohibited.	Minimum width: A & B =18”, C = 24”	Equine steps off bridge Exhibitor steps onto bridge
Jump	No more than one jump may be included in a course. Ground poles are required. Equine must clear jump without touching (clear round). Exhibitor is not permitted to jump obstacles. Jumps must be at least 5 feet wide & must be spaced 16 feet from other obstacles.	A & B: Max 12” in height C: Max 18” in height Equines under 24 months & all donkeys: Max 6” in height	Equine knocks down any part of the jump. Exhibitors knocks down any part of jump
Water, Tarp, Carpet, Mat	Equine is to walk over obstacles as prescribed by pattern. Tarp edges must be secured. Obstacle dimensions should be a minimum of 24 inches wide by 5 feet long. Equine must walk over obstacles. Exhibitors are not permitted to walk on obstacles. Water may be poured to create a water obstacle.	Minimum width: A & B = 18”, C = 24”	Equine steps to side of obstacle Equine steps completely off obstacle Equine fails to walk over obstacle. Equine jumps, leaps or evades obstacle
Ground Walk/Trot Poles	Equine must walk or trot over sequence of ground poles without touching poles. Poles can be set in straight line, zigzag or fan shaped pattern. Maximum of 6 poles in a row may be used.	Walk Over between poles: A & B=16” to 20”, C=18” to 24” Trot Over between poles: A & B=20” to 24”, C=24” to 28”	Exhibitor doesn’t remain outside of obstacle. Equine jumps, leaps, refuses, or evades poles. Equine ticks, hits, knocks, or rolls pole
Elevated Walk/Trot Poles	Equine must walk or trot over a single elevated pole or a series of elevated poles. Exhibitors is not permitted to go over poles	Single pole maximum height: A & B=8”, C=12” Multiple pole maximum height: A & B=6”, C=10” Maximum distance same as for trot over ground poles above	Equine refuses Equine goes around. Equine knocks down pole(s) Exhibitor goes over poles

4-H EQUINE PROGRAM RULEBOOK

“Pattern” Category Obstacles

Obstacle	Information	Category Adjustments	Penalties
Lead Through Poles	Equine must walk or trot through a sequence of parallel ground poles. Poles can be set in straight line, zigzag or other shaped pattern.	Minimum width between poles: A=24”, B=28”, C=30”	Exhibitor doesn’t remain outside of obstacle. Equine jumps, leaps, refuses, or evades poles. Equine steps out of obstacle
Walk/Trot Cones	Exhibitor must guide equine through cones spaced equal distances apart. Sequence should include 4-6 cones. Potted plants, or similar objects, may be used in place of cones.	Minimum distance between cones: A & B=6’, C=8’ Maximum distance between cones: A & B=8’, C=12’	Equine not willing to work through cones. Equine is not at designated gait

“Control” Category Obstacles

Obstacle	Information	Category Adjustments	Penalties
Backing Through	Equine must back through a preset pattern of poles or markers. Poles may be set in any pattern such as an L, V or parallel lines.	A & B - minimum 30” apart C – minimum of 40” apart	Exhibitor doesn’t remain outside of obstacle. Equine isn’t outside of obstacle before backing. Equine doesn’t back correct number of steps
Ground Tie	Stand equine at a designated location while exhibitor moves around or away from & back to animal	No adjustments required	Equine does not stay in place
Turn-In Square	Square will be made of four 3”- 4” diameter poles. Exhibitor must: enter square, turn equine as required, & leave square. Patterns may require the equine to turn 90°, 180°, 270° or 360° in box. Exhibitor must be within square, unless directed otherwise by pattern.	A & B: each pole 5-6 feet long C: each pole 7-8 feet long	Exhibitor touches poles or steps outside square Equine steps outside of box
Pivot Obstacles	Equine’s front/rear legs are placed in circle & forehand/haunch turn is performed turn as designated in pattern. Circle may be soft rope, chalk, or plywood & must be 12-24” in diameter	No adjustments are necessary for different height categories.	Equine steps outside of circle Equine fails to pivot correct distance
Side Pass Obstacles	Equine must side pass over a pole. Physically pushing or hitting equine constitutes illegal cueing.	Minimum width for all sizes: 24” Maximum height for all sizes: 6”	Equine steps over pole (if present) Equine fails to side pass

4-H EQUINE PROGRAM RULEBOOK

“Under” Category Obstacles

Obstacle	Information	Category Adjustments	Penalties
Tunnels, Curtains, Carwash	Equine must walk under an obstacle that is over or on both sides of the equine.	Minimum height for all sizes is 7' Minimum width for all sizes is 5'	Equine refuses to pass under obstacle. Equine shies while passing under obstacle. Exhibitor goes through obstacle with equine
Hula Hoop	Equine must stand with front feet in hula hoop & then stand quietly while hoop is passed over his head & body & then lowered to the ground around back legs. Alternatively, back legs may be placed in hoop & the hula hoop passed from back to front over equine’s head.	May not be used as an obstacle if there is an equine that is too large to pass through it. Different sized hula hoops may be used for each height category.	Equine shies from hoop Hoop isn’t passed completely over equine. Exhibitor forces equine through hoop

“Daily Chores” Category Obstacles

Obstacle	Information	Category Adjustments	Penalties
Gate Obstacles	Equine & exhibitor must go through the gate & close gate behind them. One hand should remain on the gate at all times.	No adjustments required.	Exhibitor loses control/contact with gate. Equine not willing to walk through & stand quietly.
Mailbox	Exhibitor shall lead equine up to the mailbox, open mailbox, remove an item from mailbox & close mailbox.	No adjustment for height category is necessary.	Equine refuses to approach mailbox. Equine fails to stand quietly
Objects	Put something on and off of equine or exhibitor (coat, blanket, etc.) Pick up & carry something (bucket, flag, etc.) No spraying obstacles are allowed	If an item is to be placed on equine, care must be taken that it will fit all sizes of equine.	Equine fails to stand quietly while exhibitor deals with the object. Equine shies while passing object

4-H EQUINE PROGRAM RULEBOOK

Small Equine In-Hand – Obstacle In-Hand Scoresheet Sample (Side 1)

4-H Small Equine In-Hand Obstacles In-Hand Score Sheet						Exhibitor #:	
Age Group: <input type="checkbox"/> Junior <input type="checkbox"/> Intermediate <input type="checkbox"/> Senior						Date:	
Height Category: <input type="checkbox"/> A <input type="checkbox"/> B <input type="checkbox"/> C							
Obstacle Description	Clean 5 points	A few minor errors 4 points	Several Minor errors 3 points	A few major errors 2 points	Several major errors 1 point	Does not attempt 0 points	
1.							
2.							
3.							
4.							
5.							
6.							
Tack & Attire	Appropriate, clean, fits well 5 points	A few minor problems 4 points	Several minor problems 3 points	A few major problems 2 points	Several major problems 1 point	Illegal or missing required items 0 points	
Appropriate Tack							
Appropriate Attire							
	Well mannered, & responsive 5 points	A few minor issues 4 points	Several minor issues 3 points	A few major issues 2 points	Several major issues 1 point	Out of control 0 points	
Equine							
	Calm & in control, Appropriate Cues 5 points	A few minor issues 4 points	Several minor issues 3 points	A few major issues 2 points	Several major issues 1 point	No control or Abusive 0 points	
Exhibitor							
Total Points		30 Point Course Penalties <ul style="list-style-type: none"> • Off course • Equine or exhibitor falls • Failure to pass through start/finish markers • Jumping with equine Disqualifications <ul style="list-style-type: none"> • Equine runs free from exhibitor • Willful abuse of equine by exhibitor • Leaving arena without permission 			Ribbon Points <ul style="list-style-type: none"> • Blue = 43-50 (85%-100%) • Red = 35-42 (70% - 84%) • White = 0-34 (0% - 69%) 		
Less points for course penalties							
Total Final Score							
Ribbon	<input type="checkbox"/> Blue <input type="checkbox"/> Red <input type="checkbox"/> White		Special Award				

[Return to Table of Contents](#)

4-H EQUINE PROGRAM RULEBOOK

Small Equine In-Hand – Obstacle In-Hand Scoresheet Sample (Side 2)

Judging and Scoring Obstacles In-Hand

Obstacles In-Hand is scored on a mathematical basis with points being awarded for each obstacle. Also assessed on manners; performance, and style; responsiveness; and competence of the exhibitor and equine.

General Penalties

- Failure to complete an obstacle and/or refusals is/are not a disqualification but should be penalized accordingly.
- An exhibitor may attempt any obstacle up to 3 times, however, the judge may send the equine onto the next obstacle at any time. Maximum time is 60 seconds per obstacle.
- Exhibitors shall be penalized for any unnecessary delay in approaching an obstacle.
- Each of the following occurrences will lead to a mandatory 30 point deduction: Negotiating obstacles in the wrong direction (off course), Taking obstacles in the wrong order (off course), Falling of the equine or exhibitor
- The judge should take the age and size of the exhibitor into account when assessing penalty points.

Penalties for specific obstacles (in addition to those mentioned above):

- **Backing:** Penalties: The exhibitor does not remain outside of the backing obstacle, The equine is not outside of the obstacle before they commence backing, The equine does not back the correct distance or number of steps.
- **Walk/Trot Poles:** Penalties: The exhibitor does not remain outside the obstacle, The equine jumps, leaps, refuses or evades the poles, The equine ticks, hits, knocks or rolls a pole.
- **Gate:** Penalties: The exhibitor loses control over the gate, The exhibitor loses contact with the gate, The equine is not willing to walk through the gate and stand quietly, The equine touches the gate.
- **Cones:** Penalties: The equine is not willing to work through the cones.
- **Turn-In Square:** Penalties: The exhibitor touches the poles or steps outside the square, The equine steps outside of the box with one foot, The equine steps completely outside of the box.
- **Bridge:** Penalties: The equine steps off the bridge, The equine should gain more points for showing expression and should lose points for fear/intimidation.
- **Jump:** Penalties: The equine knocks down jump or any part of the jump, The exhibitor knocks down the jump.
- **Water:** Penalties: The equine steps to the side of the obstacle with one foot, The equine steps completely off the tarp, The equine fails to walk over the obstacle or jumps, leaps or evades the obstacle.
- **Side Pass:** Penalties: The equine places feet over the opposite side of the pole, The exhibitor intimidates the equine to make it side pass either with lead, hand, or arm, The equine fails to side pass. Credit will be given for equines that cross over their legs as they execute the side pass.
- **Mailbox:** Penalties: The equine refuses to approach the mailbox, The equine fails to stand quietly while the exhibitor deals with the mailbox.
- **Objects:** Penalties: The equine fails to stand quietly while the exhibitor deals with the object, The equine shies while passing the object.

4-H EQUINE PROGRAM RULEBOOK

SMH – Small Equine Hunter In-Hand

SMH101 – Purpose

The objective of an In-Hand jumping class is to increase the level of communication between equine & exhibitor. In this event exhibits are judged not only on the number of jumping or course faults, but also on the exhibitor's ability to display the style, manners and way of going, speed, control and gait of their equine.

SMH102 - Scoring

1. Execution	70%
2. Overall Performance	30%
	100 points total

Definitions & penalties

Knockdown: - 4-point penalty:

- An obstacle is classified as 'knocked down' if the highest element of the obstacle is dislodged & lowered.

Refusal: 3-point penalty

- A refusal fault is incurred if an equine halts at an obstacle, discontinuing its forward motion & backs, side steps or circles to retake a fence.
- Stopping at an obstacle without backing followed by jumping from a standstill is not considered although points may be deducted for style.
- After the refusal, if the equine is moved forward towards the obstacle but does not attempt to jump, it is considered another refusal.

Unnecessary Circling: 3-point penalty

- Circling incurs a penalty if the equine is on the course. Circling is permitted prior to crossing the start line.

Run Out: 3-point penalty

- A run-out occurs when the equine evades or passes the obstacle to be jumped without jumping or attempting to jump the obstacle.
- A run-out is considered a form of refusal.

Touching Obstacle: 1 point penalty

- Any contact with the obstacle by the equine (excluding tail) or the exhibitor will incur a penalty. Includes ticks & rubs with the front or hind legs.

An automatic 30-point deduction will be given in the following situations.

- Three disobediences over the course. -A disobedience is a refusal, run-out or circling
- Failure to keep to course.
- Equine or exhibitor falls
- Exhibitor jumping obstacle with the equine.

[Return to Table of Contents](#)

4-H EQUINE PROGRAM RULEBOOK

- Jumping an obstacle before it has been reset.
- Pulling, 'lifting' or dragging the equine over an obstacle.
- Baiting a horse to jump
- Failure to pass through start & finish markers.

Disqualifications

- Equine running free from exhibitor.
- Willful abuse of the equine by the exhibitor
- Leaving arena without permission of the judge or steward

Style Points

- No equine with jumping or course faults shall place higher than a sound equine with a clear round.
- WAY OF GOING: Credit will be given to the exhibitor whose equine covers the course at an even pace, with free-flowing strides as in a brisk yet controlled trot or canter. Exhibitors will be penalized if their equine changes gait while on the course.
- STYLE: Credit will be given to equines with a correct jumping style that meets the fences squarely, in stride & jumps at the center of the fence. An equine will be penalized for unsafe jumping & bad form over fences (i.e. cat leaping, hanging a leg, rushing a fence).
- MANNERS: Credit will be given to exhibitors who handle their equine in such a way that the equine negotiates the course in a smooth, easily controlled, obedient manner. An equine will be penalized for bad mannerisms such as rearing, bucking, spooking, or shying while on the course.
- Exception: Donkeys will not be penalized for stopping before a jump and then jumping from a standstill, which is the normal donkey jumping form.

SMH103 - Attire

Refer to [SM103 - Small Equine Attire](#)

SMH104 - Equipment

Refer to [SM104 - Small Equine Equipment](#)

SMH105 - Grooming

Refer to [SM105 - Small Equine Grooming](#)

SMH106 - Class Procedures

Each exhibitor and equine will execute the course individually.

- Upon entering the arena, the exhibitor & equine may circle once prior to entering the starting point. Circling while on course will be subject to penalty.
- A warm-up jump will be provided for exhibitors to use before the jumping competition begins.

[Return to Table of Contents](#)

4-H EQUINE PROGRAM RULEBOOK

Course Layout

The course will consist of 6 jumps with at least one, but no more than 4, changes of direction. Individual jumps may be repeated to get a total of 6 jumps. The jumps may be attractive and varied or they may be standard post and rail jumps.

Hunter courses are designed to allow the exhibitor to present the horse to its best advantage. Longer distances and wide corners are utilized to enable a smooth presentation. Exhibitors will not be asked for tight turns. Angled jumps must be approached from the long corner, not the short corners. Hunter courses consist of two or three straight or gently curved lines of jumps that do not require turns between them, or single jumps, with room for wide corners between lines and jumps.

Start and finish lines must be placed at least 30 feet from the first and last obstacle and be indicated by two markers at least 4 feet apart. Equines must cross the start/finish line in the proper direction to officially start and complete the course.

Jumps

- Jump standards must be short enough for all exhibitors to run past without catching the lead on the standard. The maximum height for standards is 40".
- Jumping poles will be made of schedule 40 PVC piping that is 1½" to 2" in diameter.
- All jumps must be at least 5 feet wide.
- Sight ground poles are required for all jumps.
- Jumps set at 32 inches or more in height must have a second rail added.
- Decorations must not protrude more than 24 inches from the uprights.
- At least 2 fences must be set at the maximum height, or, if the standards are not able to be set at the maximum height, no less than 2" below maximum height.
- Distances between fences in a line must be shown on the course diagram and measured when setting the course.
- A minimum of 30 feet of actual travel distance from center of one jump to center of the next must be maintained, except in the case of an in-and-out.
- An in-and-out is considered one obstacle.
- The maximum height of the bar on the second element of an in-and-out must not exceed 24 inches. The first bar should be set lower than the second element.
- An in-and-out may not be the first jump on the course or the first jump in a line.

Jump Heights - will be adjusted as follows to allow for different categories of equine:

- Category A: jump height 10"-20" In-and-out spacing 10'
- Category B: jump height 12"-22" In-and-out spacing 12'
- Category C: jump height 14"-24" In-and-out spacing 14'

4-H EQUINE PROGRAM RULEBOOK

Soundness Check

Equine must be serviceably sound. Exhibitors who are not disqualified from the class must jog for soundness past the judge (either individually after completing their course or as a group after all exhibitors have jumped) before final placings are awarded.



4-H EQUINE PROGRAM RULEBOOK

Small Equine In-Hand – Hunter In-Hand Scoresheet Sample

Small Equine In-Hand Score Sheet

Hunter In-Hand

revised 2/14/2024

Ex #:	Age Group: <input type="checkbox"/> Jr <input type="checkbox"/> Int <input type="checkbox"/> Sr	Height Category: <input type="checkbox"/> A <input type="checkbox"/> B <input type="checkbox"/> C				
Jumping Scores						
Jump	Clear 5 points	Tick 4 points	Circling, Refusal, Run-out- Completes Jump 2 points	Knockdown 1 point	Does not jump 0 points	
1						
2						
3						
4						
5						
6						
Jumps Subtotal:						
Collective Scores						
Attire & Tack	Appropriate, clean, fits well 5 points	A few minor issues 4 points	%	A few major issues 2 points	Several major issues 1 point	Illegal or missing required items 0 points
Attire						
Tack						
	Consistent gait, good form 5 points	Consistent gait, form a little off 4 points	A few gait breaks 3 points	Poor jumping form 2 points	Multiple gait breaks 1 point	Multiple gait breaks & poor form 0 points
Way of Going/Style						
	Mannered, responsive 5 points	A few minor issues 4 points	Several minor issues 3 points	A few major issues 2 points	Several major issues 1 point	Out of control 0 points
Manners						
Collective Subtotal						
Jumps Subtotal		<ul style="list-style-type: none"> • 30 Point Course Faults - Up to 30 Points • Off course • Equine/Exhibitor falls • Failure to pass start/finish • Exhibitor jumps with equine • Pulling/lifting/ over obstacle • Baiting equine to jump • Disqualifications • Equine runs free (breaks loose) • Willful abuse by exhibitor • Leaving the arena without permission 		Ribbon Points <ul style="list-style-type: none"> • Blue = 43-50 (85%-100%) • Red = 35-42 (70%-84%) • White = 0-34 (0%-69%) 		
Collective Subtotal						
Subtotal				Special Award:		
Less Course Faults						
Final Score		Ribbon: <input type="checkbox"/> Blue <input type="checkbox"/> Red <input type="checkbox"/> White				

[Return to Table of Contents](#)

4-H EQUINE PROGRAM RULEBOOK

RN – Reining

RN101 - Purpose

The Reining class is designed for a rider to exhibit their horse through a pattern of advanced performance maneuvers. When done correctly, this class has a fairly high degree of difficulty because it requires speed, control, and precision while accurately completing a series of advanced maneuvers, such as circles, spins, sliding stops, change of leads, and rollbacks. Patterns and criteria can be revised to reflect 4-H ages and levels.

RN102 - Scoring

Every horse and rider combination starts with a score of 70, and for each maneuver they can receive positive or negative maneuver points. There is also the possibility for them to incur penalty points. Reining is judged on three main concepts: functional correctness, maneuvers and attitude.

Gaited Horses – Refer to [GR106.3](#)

Each Maneuver should be scored according to the following scale:

- 1 ½ = extremely poor
- 1 = very poor
- ½ = poor
- 0 = correct
- + ½ = good
- + 1 = very good
- + 1 ½ = excellent

Penalty Application:

There are certain penalties which are applied should the rider not execute a precise maneuver or deviate from the exact written pattern. These penalty points have a negative impact as they are deducted from the final score.

Score of 0:

- Use of illegal equipment (including whips or bats)
- Use of more than index finger between reins when using 1 hand
- Failure to complete the pattern as written
- Equipment failure that delays the pattern
- Performing maneuvers other than in the specified order.
- The inclusion of maneuvers not specified, including but not limited to:
 - Backing more than 2 strides
 - Turning more than 90 degrees
- Stopping (exception is a complete stop in the 1st quarter of a circle is not considered an inclusion of maneuver but a break of gait and therefore a 2 point break of gait penalty will apply.

[Return to Table of Contents](#)

4-H EQUINE PROGRAM RULEBOOK

- Balking or refusal of command where pattern is delayed.
- Running away or failing to control horse.
- Jogging in excess of ½ circle or ½ the length of the arena
- Over spins of more than ¼ turn.
- Fall to the ground of horse and rider.
- Dropping a rein that contacts the ground while the horse is in motion.
- Abuse of an animal in the show arena and/or evidence that abuse has occurred prior to or during the exhibition.
- Failure to have correct exhibitor number displayed.

Penalty of 3 Points

- Break of gait
- Freezing up in spins or rollbacks
- On walk in patterns, cantering prior to reaching the center of the arena and/or failure to stop or walk before executing a canter departure.
- On run in patterns, failure to be in a canter prior to reaching the first marker.
- If a horse does not completely pass the specified marker before initiating a stop position.
- Starting or performing circles or eights out of lead will be judged as follows:
 - Each time a horse is out of lead or has a delayed change of lead, a judge is required to deduct one point, which is cumulative.
 - The judge will add one penalty point for each ¼ of the circumference of a circle or any part thereof that a horse is out of lead. A delayed change of lead is a one point penalty from one stride to ¼ of the circle.

Penalty of 5 Points

- Spurring in front of the cinch.
- Use of free hand to instill fear
- Holding the saddle or touching the horse with free hand
- Blatant disobedience including kicking, biting, bucking or rearing

Additional Penalties

- Deduct ½ point for starting a circle at a jog or exciting rollbacks at a jog up to two strides. Jogging beyond two strides but less than ½ the circle or ½ the length of the arena, deduct 2 points.
- Deduct ½ point for over or under spinning up to 1/8 of a turn; deduct 1 point for over or under spinning up to ¼ of a turn.
- In patterns required a run-around, failure to be on the correct lead when rounding the end of the arena will be penalized as follows: for ½ turn or less – 1 point; for more than 1/2 the turn – 2 points.
- Deduct ½ point for failure to remain a minimum of 20 feet from wall or fence when approaching a stop and/rollback.

4-H EQUINE PROGRAM RULEBOOK

Suggested Danish Ribbon Placing:

- Blue: 63 and up
- Red: 56 through 62
- White 0 through 55

RN103 - Attire

See [WEQ103 - Western Equitation Attire](#)

Optional

- Chaps

RN104 - Equipment

See Western Equitation Division for Tack with the exception that protective leg wraps/boots are allowed.



4-H EQUINE PROGRAM RULEBOOK

DI – Disciplined Rail

DI101 - Purpose

This is an equitation class in which the rider performs maneuvers as a group, as a rail equitation class (i.e. no individual work).

Disciplined rail is a class that tests the skills of both the horse and rider as they execute specific gaits, transitions, and/or movements as requested by the judge. The horse should respond to the rider with the least possible effort on the part of the rider and the least amount of resistance from the horse.

DI102 – Scoring

Judges are to score riders as an equitation class on their ability to perform the requested gaits and maneuvers while maintaining their correct position.

The judge is encouraged to call for reasonable tests of horsemanship with the rider demonstrating overall equitation as related to seat and hands and performance.

The member will be judged on correct posture, smooth gait transitions, and effective use of aids, with special emphasis on light hands. The performance of the horse is not to be considered more important than the methods used by the rider in obtaining that performance.

This is not a game (i.e. “Simon Says”) or an elimination/out class.

Gaited Horses – Refer to [GR106.3](#)

DI103 - Attire

See appropriate Discipline for attire.

- [HEQ103 - Hunt Seat Equitation Attire](#)
- [SEQ103 - Saddle Seat Equitation Attire](#)
- [WEQ103 - Western Equitation Attire](#)

DI104 – Equipment

See Appropriate Discipline for bridle/bit requirements.

- [DR104 - Dressage Equipment](#)
- [HEQ104 - Hunt Seat Equitation Equipment](#)
- [SEQ104 - Saddle Seat Equitation Equipment](#)
- [WEQ104 - Western Equitation Equipment](#)



4-H EQUINE PROGRAM RULEBOOK

DI105 – Grooming

See [Appropriate Discipline for Grooming](#).

- [DR105 - Dressage Grooming](#)
- [HEQ105 - Hunt Seat Equitation Grooming](#)
- [SEQ105 - Saddle Seat Equitation Grooming](#)
- [WEQ105 - Western Equitation Grooming](#)

DI106 – Class Procedure

This is a group class where all exhibitors execute the tests asked by the judge at the same time or under the judge's direction. The following are some, but not all, of the maneuvers the judge may ask you to perform:

- Enter ring on right track.
- Transitions to and from any gait, such as trot to lope or canter, hand gallop to halt, halt to lope or canter, trot to counter canter, etc. You may also be asked to perform a gait for a specific number of steps or strides.
- Extension and collection of any gait.
- Lope/canter on correct lead
- Starting and traveling on the incorrect lead/counter canter.
- Hand gallop/extended canter/extended lope (depending on seat and/or number of exhibitors)
- Change leads—simple, interrupted, or flying (Example: “As you pass in front of the judge, perform a simple change of lead.”)
- Ride without irons/stirrups and drop and pick up irons/stirrups
- Haunch or forward turn (need forward motion), judge may ask for specific number of degrees.
- Turn on forehand and turn on hind quarter (once each way).
- Leg Yield such as away from and back to the rail.
- Side pass both away from the rail (at least five steps) and then back to the rail.
- Transition from any gait to a balanced halt/stop
- Starting into a lope or canter from a halt.
- Reverse at a jog/trot (but not at lope/canter)
- Change of diagonals (English)
- Back
- Walk “on the buckle”.
- Stand for inspection or stop and stand quietly on a loose rein.
- Answer questions from Washington State 4-H Equine project materials
- The judge may ask for additional safe work reflective of horsemanship and equitation.



[Return to Table of Contents](#)

4-H EQUINE PROGRAM RULEBOOK

EP – Equine Presentations

Public Presentations/Demonstrations are an excellent activity for teaching youth to learn how to research topics, organize and present an idea using teaching skills with or without using visual aids. Giving a presentation or demonstration in front of an audience will help them to think on their feet and to speak in front of a group of peers and families. This is a great and fun way to begin to prepare for more challenging events that may involve speaking in front of various groups. For more information on 4-H Public Presentations, go to:

[WSU Publications - Public Presentations Demonstrations and Illustrated Talk](#)

[WSU Publications - Getting to the point how to do a 4-H public presentation](#)

[WSU Publications - Public Speaking 4-H Member Manual](#)

State 4-H Equine Presentations differ from other 4-H public presentations in two ways: the topic/subject must pertain to the equine industry; and each contest has very defined time constraints and penalties. In public speaking, the information is delivered as a speech and no visual aids are allowed. The State Contest is open only to Senior Members and each County may enter one Individual Presentation, one Team (2) Presentation and one Public Speaking.

Go to [WA State 4-H Horse website page](#), for contest rules and information.

GS – Groom Squad

Groom Squad is a fun, team-building contest that may be offered at the Club or County level and is a State 4-H Fair Contest for a Senior Team from each County. Members participate in Teams of 3 and demonstrate their skill at grooming a horse where their tools, use of tools and method of grooming are all evaluated along with their teamwork and overall safety in grooming, handling, and showing the horse in showmanship. One member will take a written exam that sources questions from any of the Washington State 4-H Equine Publications. One member will exhibit the team's equine in a Showmanship Class. Scores are tabulated and awards presented.

Go to [WA State 4-H Horse website page](#), for contest rules and information.

HI - Hippology

Hippology is a Greek word with the root word “hippo” meaning horse and “ology” meaning the study of. Hippology contests have four phases: exam, identification stations, judging, and team problem solving. Contest questions are designed to evaluate 4-H member's knowledge of a broad range of equine topics. All questions asked in our WA State 4-H Hippology Contest are taken from specified sources. The source list is available on the [WA State 4-H Horse website page](#), along with contest rules and information.

The primary objectives of the Hippology Contest are to provide, in a friendly but competitive setting:

- the opportunity to blend equine science and husbandry with horse judging and public speaking into one activity where 4-H members can apply their acquired knowledge and skill;

[Return to Table of Contents](#)

4-H EQUINE PROGRAM RULEBOOK

- to encourage youth to continue expanding their horse knowledge and participation in various equine events;
- to recognize youth for their comprehension of the many facets of the horse industry; and
- to teach good sportsmanship and encourage leadership

HB – Horse Bowl

A Horse Bowl Contest is a Quiz Bowl with teams, a moderator to ask questions, and a buzzer system for participants to indicate they know and want to answer the question. The State 4-H Horse Bowl Contest has matches with 30 questions. County Contests may have less questions in a match due to time constraints. Topics are all horse-related and cover a broad spectrum including, but not limited to, parts of the horse, colors and markings, tack, feeding, health, internal anatomy, disease, breeds, parasites, and more.

The primary objectives of Horse Bowl Contests are to provide, in a friendly but competitive setting:

- the opportunity to blend equine science and husbandry where 4-Hers can apply their acquired knowledge;
- to encourage youth to continue expanding their horse knowledge and participation in various equine events;
- to recognize youth for their comprehension of the many facets of the horse industry;
- to teach good sportsmanship and encourage leadership.
- For State 4-H Horse Bowl Rules and Sources, refer to the [“Horse Page” on the WSU Website](#).

HJ – Horse Judging

Horse Judging, as is all judging in 4-H, designed to teach basic decision-making life skills. Learning how to research criteria, evaluate options and make a decision is a critical life skill, however in horse judging, youth also learn how to evaluate equines at halter (conformation) and under saddle (Equitation, Pleasure, etc.)

A class consists of 4 entries clearly identified as 1, 2, 3 and 4. At the “learning level” the Official Judge will review the criteria for the class then the class will be run giving all youth the best opportunity to view each entry. The participants will mark their provided judging cards and either hand them in or have them highlighted by an official. The judge will then announce their official placing, cuts and reasons for placing the class.

The State 4-H Horse Judging Contest is held during the State 4-H Fair. All Counties may send up to 10 Juniors, 10 Intermediates and 10 Senior members. The Contest consists of 6 classes (Halter and Performance) with Intermediates giving one set of Oral Reasons and Seniors presenting two sets of Oral Reasons. Juniors do not do Oral Reasons at the State Contest. For detailed information on how to enter this State Contest, please refer to the current edition of the State 4-H Exhibitor's Guide.

4-H EQUINE PROGRAM RULEBOOK

Sources for study are located on the [WSU Publications website](#). [PNW575 – 4-H Horse Judging Manual](#) is the most useful source, however, the Washington State 4-H Equine Rule Book and breed association websites are also great study sources.

HA – Horse Advancement Program

This is a competency-based program designed for 4-H leaders to assist Junior, Intermediate and Senior members with a checklist to build the competency and confidence of 4-H Horse Members. Youth will gain skills and experiences that will assist their success in the Horse Program.

Each Step builds upon the previous Step based in terms of skill level and age appropriateness. Each age group will experience activities around the Essential Elements of 4-H Youth Development – Belonging, Mastery, Independence and Generosity.

Each Club or County can design the recognition model that best fits the needs and interests of the members.

[Member Guide – EM2790E](#)

[Leader Guide – EM4869E](#)

HH - Horseless Horse Project

A youth may choose to enroll in the Horseless Horse Project. Clubs and counties are encouraged to provide educational opportunities (e.g., Equine Science, Equine Presentations, Horse Bowl, Hippology) for youth without access to an equine.

Cloverbuds may also enroll in the Horseless Horse project, however they are prohibited from direct contact with equines at 4-H events.

Check out the [Horse are Fun publication](#)

4-H EQUINE PROGRAM RULEBOOK

Revised by the Washington State 4-H Equine Rule Book Sub-Committee

Committee Members:

Jennifer Leach, Washington State University 4-H Equine Specialist

Kim Baker, Washington State University 4-H Equine Coordinator

Stephanie Roeter, 4-H Regional Specialist

Kate McCloskey, Spokane County 4-H Program Coordinator

R-A Mazzola, Island County 4-H Program Coordinator

Pat Pehling, 4-H Volunteer

Connie Medeiros, 4-H Volunteer and Washington State Fair 4-H Equine Superintendent

Dusti Kissler, 4-H Judge

Dawn Spencer, 4-H Judge

Patti Burns, 4-H Judge

Anne Garrett, 4-H Judge

Approved by the Washington State 4-H Equine Committee.

Committee Members:

Jennifer Leach, Washington State University 4-H Equine Specialist

Kim Baker, Washington State University 4-H Equine Coordinator

Stephanie Roeter, 4-H Regional Specialist

Kate McCloskey, Spokane County 4-H Program Coordinator

Deborah Moberg-Williams, Walla Walla County 4-H Faculty

Kristine Shackley, Thurston County 4-H Program Assistant

Carolyn Russo, Grant County 4-H Program Coordinator

R-A Mazzola, Island County 4-H Program Coordinator

Alyssa Bowers, King County 4-H Director and 4-H Assistant Professor

Pat Pehling, 4-H Volunteer

Connie Medeiros, 4-H Volunteer and Washington State Fair 4-H Equine Superintendent

Kim Lansing, 4-H Volunteer and Chair of Washington State Junior Horse Show

Jennifer Loyd, Yakima 4-H Program Coordinator

Adapted from The PNW 4-H Horse Contest Guide-PNW 574.

Washington State Past PNW Committee Members-Jerry Newman, 4-H Animal Science Specialist (retired); Jennifer Leach, 4-H Equine Specialist; Pat Pehling 4-H Volunteer; Marilyn Anderson-4-H Volunteer; Anne Garrett-PNW 4-H Horse Judge, Doug Evenson, PNW 4-H Horse Judge.

Suggestions for corrections, changes, or addition of new rules or disciplines must be sent to the State 4-H Equine contact who will forward to the State 4-H Equine Rules Committee and the State 4-H Equine Committee for final decision with final approval of the Washington 4-H Program Director. Approved changes and/or additions would be effective October 1 of the next 4-H Program year.

Please refer to the WSU 4-H Equine page [4-H Website](#) for deadline dates, request process, contact information, and other information related to this Washington 4-H Equine Rule Book. State 4-H Horse Contact: jleach@wsu.edu or LeachJ@cowlitzwa.us, Phone: 360-577-3014 ext. 4

[Return to Table of Contents](#)